

# COMPLETE SYSTEM ORDERING MANUAL

## RANSHU NEW UNIT WARRANTY POLICY

PARTS REPLACEMENT UP TO 30 DAYS FROM INSTALL DATE. NO LABOR

### TABLE OF CONTENTS

CHRYSLER CORPORATION	PAGES	917 - 919
JEEP		920 - 921
FORD/MERCURY	PAGES	922 - 927
GENERAL MOTORS	PAGES	928 - 934
CHEVROLET/GEO CARS		928 - 929
CHEVROLET/GMC PICKUPS		929 - 931
CHEVROLET/GMC TRUCKS & VANS		932 - 934
BUICK		934
OLDSMOBILE		934
PONTIAC		934
SATURN		934
INTERNATIONAL-NAVISTAR	PAGE	935
STERLING	PAGE	935
IMPORTS	PAGES	936 - 948
ACURA		936
DAEWOO		936
HONDA		936 - 937
HYUNDAI		937
ISUZU		938
KIA		938 - 939
MAZDA		939 - 941
MINI		941 - 942
NISSAN		942 - 944
SUZUKI		945
TOYOTA		946 - 947
VOLKSWAGEN		947 - 948
UNIVERSAL AND SPECIAL APPLICATION		949 - 950
VINTAGE AIR		951 - 958
CRUISE CONTROL		959 - 964
COMPRESSOR REFERENCE		965
CLUTCH AIR GAPS		966
COMPRESSOR OIL CAPACITIES		967
COMPRESSOR PRESSURE GUIDE		968
GM SEALING WASHER GUIDE		969 - 971
POLICY & PROCEDURE GUIDE		972 - 980

You receive a 24% DISCOUNT from prices listed in the System Ordering Manual.  
Multiply the listed price times .76 to calculate your cost on new A/C install units and cruise controls.

# CHRYSLER CORPORATION

## CALIBER

MODEL YEAR	ENGINE SIZE	A.I. PUMP	STEERING	EVAPORATOR KIT	COMPRESSOR	ENGINE KIT	TOTAL PRICE	NOTES
2012-09	AUTO TRANS 1.8, 2.0, 2.4	WO	PWR	BM97CH057	UNIT PACKED		\$2,550.00	2
2012-09	MANUAL TRANS 1.8, 2.0, 2.4	WO	PWR	BM97CH045-1-2	UC45141	C-3105	\$1,800.00	1,2,3
2012-06	2.0L	WO	PWR	BM97CH045-1-2	UC45141	C-3105	\$1,800.00	1,2,3

1) GRAPHIC PANEL NOT PROVIDED IN KIT. CONTROL IS BY MICRO SWITCH & O.E CONTROL HEAD PROVIDED

2) VEHICLE NOT PROGRAMMED FOR A/C FUNCTION, SO REMOTE SWITCH IS PROVIDED

3) THIS UNIT USES A FACTORY COIL AND MAINTAINS EXISTING CONTROL BUT ADDS A PUSH BUTTON SWITCH TO POWER COMPRESSOR

## COLT/EAGLE SUMMIT SEDAN

YEAR	ENGINE SIZE	PUMP	STEERING	KIT	COMPRESSOR	ENGINE KIT	PRICE	NOTES
1992-89	4 CYL 1.5L FWD	WO	STD/PWR	BM97CH016-1-2	UC55021	P-2870 / C-3045	\$1,224.48	1

1) WILL NOT FIT 1.6L

## COLT VISTA (MINI VAN) / EAGLE SUMMIT WAGON

MODEL YEAR	ENGINE SIZE	A.I. PUMP	STEERING	EVAPORATOR KIT	COMPRESSOR	ENGINE KIT	TOTAL PRICE	NOTES
1996-92	1.8L	WO	PWR	CM2881	UC55121	P-2830	\$911.00	

## LASER / TALON

MODEL YEAR	ENGINE SIZE	A.I. PUMP	STEERING	EVAPORATOR KIT	COMPRESSOR	ENGINE KIT	TOTAL PRICE	NOTES
1994-90	2.0L	WO	STD/PWR	SF30-0022	UC55121	C-3070	\$700.00	
1994-90	1.8L	WO	STD/PWR	SF30-0022	UC42118	C-3083	\$725.00	

1) NON-TURBO HAS COMPRESSOR ON PASSENGER'S SIDE

2) WHEN SUPPLY IS EXHAUSTED PLEASE ORDER BM97CH020-1-2. MUST KNOW YEAR FOR PROPER SWITCHING

## LeBARON / DAYTONA

MODEL YEAR	ENGINE SIZE	A.I. PUMP	STEERING	EVAPORATOR KIT	COMPRESSOR	ENGINE KIT	TOTAL PRICE	NOTES
1994-91	2.2L 2.5L	W	STD/PWR	SF30-0011	UC55021	C-3065	\$850.00	1

1) IF NOT EQUIPPED WITH HD FAN ORDER FA910034 \$80.00

## NEON

MODEL YEAR	ENGINE SIZE	A.I. PUMP	STEERING	EVAPORATOR KIT	COMPRESSOR	ENGINE KIT	TOTAL PRICE	NOTES
2006-04	2.0L	WO	PWR	BM97CH040-1-2	UC52038	P-5170	\$2,185.00	6,7
2003-01	2.0L	WO	PWR	BM97CH030-1-2	UC52038	P-5170	\$1,525.00	3,4,5
2001-00	2.0L	WO	PWR	CM2109	UC52038	P-5170	\$706.00	3
1999-94	2.0L	WO	STD	BM97CH014-1-2	UC7312	P-3580	\$1,600.00	1,2

1) ORDER SWITCH - NON FACTORY CM4402039-58 INCLUDED IN PRICE - FACTORY SWITCHING ADD \$120, ONLY GREY AVAILABLE NOW

2) RADIATOR KIT CM3502039-60 MUST BE ADDED TO CARS WITHOUT LARGE RADIATOR ADD \$294.00 TO TOTAL PRICE

3) PLEASE NOTE SOME CARS COME W/ FACTORY A/C CASE OR COMPRESSOR MOUNT BRACKET ALREADY INSTALLED. PLEASE CALL BEFORE BIDDING JOB

4) THIS KIT ONLY FITS NEON WITH FACTORY A/C CASE 5) UNIT WITH O.E CONTROLS BM97CH039-1-2 ADD \$279

6) FOR PRODUCTION DATE AFTER 11/13/03. UNIT WITH O.E. CONTROLS AVAILABLE BM97CH041-1-2 ADD \$297

7) UNIT WITH OEM CONTROLS AVAILABLE BM97CH041-1-2 ADD \$226

## P T CRUISER

MODEL YEAR	ENGINE SIZE	A.I. PUMP	STEERING	EVAPORATOR KIT	COMPRESSOR	ENGINE KIT	TOTAL PRICE	NOTES
2008-06	2.4L	WO	PWR	BM97CH044-1-2	14-5044NC	C-3103	\$2,330.00	
2005	2.4L	WO	PWR	BM97CH042-1-2	14-5044NC	C-3103	\$2,330.00	1,2

1) GET VIN # FOR CONTROL HEAD AND BEZEL

2) 2005 PT CRUISER WITH TAN INTERIOR, ORDER BM97CH043-1-2 EVAP FOR PROPER TRIM BEZEL

# CHRYSLER CORPORATION

## SHADOW / SUNDANCE / SPIRIT / ACCLAIM

MODEL YEAR	ENGINE SIZE	A.I. PUMP	STEERING	EVAPORATOR KIT	COMPRESSOR	ENGINE KIT	TOTAL PRICE	NOTES
1994-91	2.2L 2.5L	W	STD/PWR	SF30-0011	UC55021	C-3065	\$850.00	1

1) FA910034 HD RADIATOR FAN MOTOR REQUIRED ON MODELS WITH O.E. TWO BLADE FAN \$80.00

## RAIDER

MODEL YEAR	ENGINE SIZE	A.I. PUMP	STEERING	EVAPORATOR KIT	COMPRESSOR	ENGINE KIT	TOTAL PRICE	NOTES
1991-87	3.0L	WO	STD/PWR	BM97CH006-1-2	UC55021	C-3072	\$1,490.00	

## CARAVAN / VOYAGER

MODEL YEAR	ENGINE SIZE	A.I. PUMP	STEERING	EVAPORATOR KIT	COMPRESSOR	ENGINE KIT	TOTAL PRICE	NOTES
1995-93	2.5L	W	STD/PWR	SFCH-22934	UC55021	C-3065	\$975.00	1
1995-93	3.0L	WO	STD/PWR	SFCH-22934	UC55021	P-1460 / C-3053	\$838.00	1
1995-93	3.3L	WO	PWR	SFCH-22934	UC55121	P-1901 / C-3068	\$839.00	1

1) PLEASE CALL FIRST--LIMITED SUPPLY

## VAN

MODEL YEAR	ENGINE SIZE	A.I. PUMP	STEERING	EVAPORATOR KIT	COMPRESSOR	ENGINE KIT	TOTAL PRICE	NOTES
2005-96	3.9L 5.2L 5.9L	WO	PWR	N.L.A.				
1995-79	VARIOUS			N.L.A.				

## RAM 50 PICKUP

MODEL YEAR	ENGINE SIZE	A.I. PUMP	STEERING	EVAPORATOR KIT	COMPRESSOR	ENGINE KIT	TOTAL PRICE	NOTES
1995-87	4 CYL 2000/2400CC	WO	STD/PWR	CM2849-4CYL	UNIT PACK		\$1,000.00	1,2,3
1993-90	V-6 3.0L 2WD ONLY	WO	STD/PWR	BM97CH008-1-2	UC55021	P-2110	\$1,480.00	
1989-87	4 CYL 2600CC	WO	STD/PWR	BM97CH008-1-2	UC55021	P-1520 / C-3041	\$1,495.00	4

1) SHROUD PACKAGE RECOMMENDED FOR 2.0L VEHICLES MANUAL TRANSMISSION ORDER FROM DEALER

2) 14-0734 SHROUD PACKAGE RECOMMENDED FOR 2.0L VEHICLES AUTOMATIC TRANSMISSION \$70.00

3) 14-0735 SHROUD PACKAGE RECOMMENDED FOR 2.0L VEHICLES WITH 4 WHEEL DRIVE \$70.00

4) ORDER FAN SHROUD SF70-3070 \$75.00

# CHRYSLER CORPORATION

## DAKOTA

MODEL YEAR	ENGINE SIZE	A.I. PUMP	STEERING	EVAPORATOR KIT	COMPRESSOR	ENGINE KIT	TOTAL PRICE	
2004-01	4 CYL	W	STD/PWR	BM97CH036-1-2	UC55141	C-3092	\$1,920.00	4,5
2004-01	3.9 5.9	W	STD/PWR	BM97CH037-1-2	UC55121	P-3751 / C-3089	\$1,940.00	4,5
2004-01	4.7	W/WO	STD/PWR	BM97CH037-1-2	UC55121	P-5500	\$1,900.00	4.5
2000-97	2.5L	W/WO	STD/PWR	CM2066	UC55121	C-3092	\$1,355.00	
2000-97	3.9L 5.2L 5.9L	WO	STD/PWR	CM2066	UC55141	P-3751 / C-3089	\$1,360.00	3
1996	2.5L	W	STD/PWR	BM97CH015-1-2	UC55121	C-3092	\$1,540.00	
1995-94	2.5L	W	STD/PWR	BM97CH015-1-2	UC55021	C-3065	\$1,680.00	
1996-94	3.9L 5.2L	WO	STD/PWR	BM97CH015-1-2	UC55141	P-3751 / C-3089	\$1,555.00	3
1993-92	3.9L 5.2L	WO	STD/PWR	BM97CH007-1-2	UC55141	P-3751 / C-3089	\$1,440.00	3
1991	3.9L	WO	PWR	BM97CH007-1-2	UC55021	P-1300	\$1,425.00	
1993-89	2.2L 2.5L	W	STD/PWR	BM97CH007-1-2	UC55021	C-3065	\$1,565.00	1
1990-89	3.9L	WO	PWR	BM97CH007-1-2	UC55021	P-1300	\$1,425.00	
1988	2.5L	W	STD/PWR	BM97CH007-1-2	UC55021	C-3065	\$1,565.00	1,2
1988	3.9L	WO	PWR	BM97CH007-1-2	UC55021	P-1300	\$1,425.00	2
1987	3.9L	WO	PWR	BM97CH007-1-2	UC55021	C-3049	\$1,425.00	2

1) HD FAN REQUIRED IF NOT EQUIP FROM FACTORY

2) ORDER BM9100070 WIRING BACKDATE \$20

3) DO NOT USE 3 EYE COMPRESSOR

4) SPECIAL ORDER MUST KNOW ENGINE SIZE AND YEAR

5) VEHICLES WITH REAR DEFROST REQUIRE DIFFERENT CONTROL HEAD, ORDER FROM DEALER

## PICKUP

MODEL YEAR	ENGINE SIZE	A.I. PUMP	STEERING	EVAPORATOR KIT	COMPRESSOR	ENGINE KIT	TOTAL PRICE	NOTES
2012-11	6.7L DSL	WO	PWR	BM97CH059	UNIT PACKED		\$2,320.00	
2010-07	6.7L DSL	WO	PWR	BM97CH054	UNIT PACKED		\$2,195.00	10
2002-99	3.9L 5.2L 5.9L	WO	PWR	BM97CH026-1-2	UC55141	P-3751 / C-3089	\$1,560.00	4,6,7
2002-99	8.0L	WO	PWR	BM97CH026-1-2	UC55121	P-4790	\$1,540.00	4,6,7
2002-97	5.9L CUMMINS	WO	PWR	BM97CH033-1-2	UC4682	C-3098	\$1,580.00	4,6,7
1998	3.9L 5.2L 5.9L	WO	PWR	BM97CH025-1-2	UC55121	P-3751 / C-3089	\$1,560.00	4,6
1997-94	3.9L 5.2L 5.9L	WO	PWR	BM97CH009-1-2	UC55141	P-3751 / C-3089	\$1,500.00	4,6
1996-94	5.9L CUMMINS	WO	PWR	BM97CH033-1-2	UC4682	C-3079	\$1,595.00	6,
1993-88	3.9L 5.2L 5.9L	WO	PWR	BM97CH004-1-2	UC55021	C-3058	\$1,180.00	
1993-92	5.9L CUMMINS	WO	PWR	BM97CH004-1-2	UC4682	C-3079	\$1,210.00	
1991-89	5.9L CUMMINS TURBO DIESEL W/O INTERCOOL	N/A	STD/PWR	BM97CH004-1-2	UC55122	C-3061	\$1,225.00	1,2,8
1987-82	V-8 318-360	W/WO	STD/PWR	BM97CH004-1-2	UC55021	C-3035	\$1,190.00	5,8
1987-81	6 CYL 3.7L 225CID	W	STD/PWR	BM97CH004-1-2	UC55021	C-3029	\$1,270.00	8
1987-81	V-8 318-360	W/WO	PWR	BM97CH004-1-2	UC55021	C-3031	\$1,180.00	8
1987-81	V-8 318-360 5.2L & 5.9L	W/WO	STD	BM97CH004-1-2	UC55021	C-3033	\$1,160.00	8
1980-73	ALL			SMCY-718	CALL			11

1) SOME HOSE MODIFICATION MAY BE REQUIRED

2) WILL NOT FIT VEHICLES WITH AUXILIARY TRANSMISSION COOLER

3) ALLOW EXTRA LABOR TIME TO CLEARANCE CONDENSER ON INTERCOOLER

4) IF VEHICLE HAS HEATED MIRRORS A DIFFERENT CONTROL HEAD IS NEEDED

5) WITH 100 AMP ALT

6) WITH FACTORY CONTROLS

7) WILL NOT FIT 2002 1500 SERIES

8) SHORT SUPPLY CALL FIRST

9) USE CM2045-00 WHEN SUPPLY EXHAUSTED

10) WITH OE COIL

11) SOME MOUNTS NOT AVAILABLE

12) MUST MENTION AUTOMATIC OR MANUAL WHEN ORDERING

# JEEP

## JEEP CHEROKEE/COMANCHE

MODEL YEAR	ENGINE SIZE	A.I. PUMP	STEERING	EVAPORATOR KIT	COMPRESSOR	ENGINE KIT	TOTAL PRICE	NOTES
1996-91	4 CYL 2.5L	WO	PWR	/98AM402-1 /98AM402-5	UC55122	C-8024	\$1,585.00	1
1996-91	6 CYL 4.0L	WO	PWR	BM97CH021-1-3	UC55122	C-8022	\$1,675.00	1
1990-87	4 CYL 2.5L	WO	STD/PWR	/98 AM402-1 /98AM402-5	UC55121	C-8010	\$1,525.00	1
1990-87	6 CYL 4.0L	WO	PWR	BM97CH002-1-3	UC4508	NOT REQUIRED	\$1,215.00	2

1) CHECK ON AVAILABILITY BEFORE QUOTING

2) 87 REQUIRES WIRING MODIFICATION

## JEEP COMPASS

MODEL YEAR	ENGINE SIZE	A.I. PUMP	STEERING	EVAPORATOR KIT	COMPRESSOR	ENGINE KIT	TOTAL PRICE	NOTES
2012-10	ALL	WO	PWR	BM97CH057	UNIT PACKED	UNIT PACKED	\$2,550.00	2,3
2009-07	2.0L 2.4L	WO	PWR	BM97CH045-1-2	UC55141	C-3105	\$1,733.00	1

1) MUST KNOW IF IT HAS REAR WINDOW DEFOGGER

2) VEHICLE NOT PROGRAMMED FOR A/C FUNCTION, SO REMOTE SWITCH IS PROVIDED

3) AUTOMATIC ONLY

## JEEP LIBERTY

YEAR	SIZE	PUMP	STEERING	KIT	COMPRESSOR	ENGINE KIT	PRICE	NOTES
2005-02	4 CYL 2.4L	WO	PWR	BM97CH032-1-2	UC55122	C-8030	\$1,435.00	2
2005-02	6 CYL 3.7L	WO	PWR	BM97CH032-1-3	UC55121	C-8029	\$1,455.00	1,2

1) CAN USE UC52114 W/C-8029 MOUNT

2) MUST SELL RELAY KIT BM9100098 \$18 AND FITTING KIT BM9100011 \$11

## JEEP PATRIOT

MODEL YEAR	ENGINE SIZE	A.I. PUMP	STEERING	EVAPORATOR KIT	COMPRESSOR	ENGINE KIT	TOTAL PRICE	NOTES
2012-10	2.0L 2.4L	WO	PWR	BM97CH057	UNIT PACKED	UNIT PACKED	\$2,550.00	2,3
2009-07	2.0L 2.4L	WO	PWR	BM97CH045-1-2	UC55141	C-3105	\$1,733.00	1

1) MUST KNOW IF IT HAS REAR WINDOW DEFOGGER

2) VEHICLE NOT PROGRAMMED FOR A/C FUNCTION, SO REMOTE SWITCH IS PROVIDED

3) AUTOMATIC ONLY

# JEEP

## WRANGLER

MODEL YEAR	ENGINE SIZE	A.I. PUMP	STEERING	EVAPORATOR KIT	COMPRESSOR	ENGINE KIT	TOTAL PRICE	NOTES
2011-07	3.8 STD TR	WO	PWR	CM2229-R	UNIT PACKED		\$1,690.00	6,9,10
2011-07	3.8 AUTO TR	WO	PWR	CM2228-R	UNIT PACKED		\$1,500.00	6,9,10,11
2006-02	6 CYL 4.0L	WO	PWR	BM97CH031-1-3	UC55141	C-8028	\$1,500.00	
2004-03	4CYL 2.4L	WO	PWR	BM97CH035-1-2	UC55122	C-8030	\$1,315.00	
2002	4 CYL 2.5L	WO	PWR	BM97CH031-1-2	UC55141	C-8025	\$1,430.00	
2001-00	6 CYL 4.0L	WO	PWR	BM97CH018-1-3	UC55141	C-8028	\$1,455.00	
2001-99	4 CYL 2.5L	WO	PWR	BM97CH018-1-2	UC55121	C-8025	\$1,270.00	
1999	6 CYL 4.0L	WO	PWR	BM97CH018-1-2	UC55122	C-8025	\$1,270.00	
1998-97	4 CYL 2.5L 6 CYL 4.0L	WO	PWR	BM97CH018-1-2	UC55121	C-8021	\$1,270.00	5
1995.5	4CYL 2.5L 6 CYL 4.0L	WO	PWR	BM97CH001-1-2	UC55121	C-8021	\$1,460.00	2, 4
1995-91	4 CYL 2.5L 6 CYL 4.0L	WO	PWR	BM97CH001-1-2	UC55121	C-8017	\$1,500.00	2, 4
1990-87	4 CYL 2.5L 6 CYL 4.0L	WO	STD/PWR	BM97CH001-1-2	UC55021	C-8011	\$1,560.00	1
1990-87	6 CYL CALIFORNIA	WO	PWR	BM97CH001-1-2	UC55121	C53000529	\$1,365.00	1,3,8
1986-84	6 CYL 2.8L	W	STD/PWR	BM97CH001M-1-2	UC52110	C-4073	\$1,530.00	
1986	4 CYL 2.5L 6 CYL 4.2L	WO	STD/PWR	BM97CH001M-1-2	UC55021	C-8011	\$1,560.00	1,7
1985-81	4 CYL 2.5L 6 CYL 4.2L	WO	STD/PWR	BM97CH001M-1-2	UC55021	C-8005	\$1,520.00	7
1982-81	4 CYL 2.0L	WO	STD/PWR	BM97CH001M-1-2	UC55021	C-8001	\$1,575.00	

- 1) FOR 1986-90 MODELS ORDER WIRE HARNESS #9100012 \$50
- 2) FOR 1991-95 MODELS WITH 4 CYL ORDER WIRE HARNESS KIT #9100056 \$51
- 3) SERPENTINE DRIVE ONLY
- 4) 11-0027A DAYCO BELT (5060945) REQUIRED FOR STD STEERING \$27
- 5) FOR 97-98 MODELS ORDER GRAPHICS PANEL #1290043 \$16
- 6) MOSTLY O. E. COMPONENTS
- 7) SERPENTINE DRIVE USE C53000529 \$35.00
- 8) BRACKET NO LONGER AVAILABLE, WE CAN BUILD FOR \$35.00 ORDER C53000529
- 9) THIS AFTERMARKET A/C SYSTEM HAS AFTERMARKET SWITCHING W/PUSH BUTTON
- 10) IF POWER WINDOW SWITCH IS INSTALLED ON VEHICLE CENTER LOUVER BEZEL, ORDER SWITCH BEZEL KIT #BM9100102 \$33
- 11) IF THE VEHICLE DOES NOT COME WITH A FACTORY INSTALLED CONDENSER ORDER KIT CM2228-C \$190

# FORD/MERCURY

## ASPIRE

MODEL YEAR	ENGINE SIZE	A.I. PUMP	STEERING	EVAPORATOR KIT	COMPRESSOR	ENGINE KIT	TOTAL PRICE	NOTES
1997-94	1.3L	WO	STD	BM97FD020-1-2	UC52114	C-7152	\$1,228.59	1

1) WILL FIT MANUAL TRANSMISSION VEHICLES ONLY, CALL IF YOU HAVE AN AUTOMATIC TRANSMISSION

## ESCORT

MODEL YEAR	ENGINE SIZE	A.I. PUMP	STEERING	EVAPORATOR KIT	COMPRESSOR	ENGINE KIT	TOTAL PRICE	NOTES
2003-99	W/ZTEC	WO	PWR	SFFD-27634	UC55122	P-5090	\$975.00	1
2002-97	2.0L	WO	PWR	SFFD-27634	UC55122	P-4450 / C-7168	\$975.00	1
1996-91	1.9L	WO	STD/PWR	BM97FD009-1-2	UC55122	C-7137	\$1,500.00	
1996-95	1.8L	WO	PWR	BM97FD009-1-2	UC55121	SF13-0529	\$1,420.00	

1) WHEN SUPPLY EXHAUSTED USE BM97FD014-1-2 AT EXTRA COST OF \$45 MUST USE UC55121 W/ BETTERMADE UNIT

## FOCUS

MODEL YEAR	ENGINE SIZE	A.I. PUMP	STEERING	EVAPORATOR KIT	COMPRESSOR	ENGINE KIT	TOTAL PRICE	NOTES
2009-08	2.0L W/AT	WO	PWR	BM97FD051R-08AT	UNIT PACKED		\$1,800.00	
2009-08	2.0L W/MT	WO	PWR	BM97FD051R-08MT	UNIT PACKED		\$1,760.00	
2007-05	ZX4	WO	PWR	BM97FD051	UNIT PACKED		\$2,085.00	1,2,5,7
2004-03	2.0L ZX3	WO	PWR	BM97FD050-1-2	UC55121	P-5210	\$2,140.00	1,2,4,6
2004-03	2.0L ZX3	WO	PWR	BM97FD043-1-3	UC55121	P-5210	\$1,600.00	1,2,6,7
2004-03	2.3L PVEC	WO	PWR	BM97FD044-1-2	UNIT PACKED		\$2,000.00	1,2,7
2004-02	2.0L ZETEC	WO	PWR	BM97FD041-1-3	UC55121	P-5210	\$1,700.00	1,2,4,5
2004-02	2.0L	WO	PWR	BM97FD031-1-3	UC55121	C-7172	\$2,125.00	1,3,4,6
2004-03	2.0L SPI	WO	PWR	BM97FD049-1-2	UC55121	C-7172	\$1,960.00	1,3,6,7
2002-01	2.0L ZX3	WO	PWR	BM97FD043-1-2	UC55121	P-5210	\$2,155.00	1,2,4,5
2001-00	2.0L	WO	PWR	BM97FD031-1-2	UC55121	C-7172	\$2,125.00	1,3,4,6
2001-00	2.0L ZETEC	WO	PWR	BM97FD041-1-2	UC55121	P-5210	\$1,865.00	1,2,4,5

1) IN ORDER TO SHIP PROPER KIT AND WIRING WE **MUST** KNOW **EXACT** ENGINE, YEAR & W/ OR W/O REAR DEFROST \$1,670.00

2) DOHC

3) SOHC

4) FOR CARS EQUIPPED WITH ONE FAN FROM FACTORY

5) FOR CARS EQUIPPED WITH A/C WIRING FROM THE FACTORY

6) FOR CARS WITHOUT FACTORY A/C WIRING

7) FOR CARS EQUIPPED WITH TWO ELECTRIC FANS FROM FACTORY

## MUSTANG

MODEL YEAR	ENGINE SIZE	A.I. PUMP	STEERING	EVAPORATOR KIT	COMPRESSOR	ENGINE KIT	TOTAL PRICE	NOTES
1966-65	V8 289			OA-CAP-365M-289	UNIT PACKED		\$1,250.00	
1966-65	L6			OA-CAP-365M-6	UNIT PACKED		\$1,250.00	

## TRACER

YEAR	ENGINE SIZE	PUMP	STEERING	KIT	COMPRESSOR	ENGINE KIT	PRICE	NOTES
2002-97	W/ZTEC	WO	PWR	SFFD-27634	UC55122	P-5090	\$975.00	1
2002-97	2.0L	WO	PWR	SFFD-27634	UC55122	P-4450 / C-7168	\$975.00	1
1996-91	1.9L	WO	STD/PWR	BM97FD009-1-2	UC55122	C-7137	\$1,155.00	
1996-95	1.8L DOHC	WO	STD/PWR	BM97FD009-1-2	UC55121	SF13-0529	\$1,082.00	

1) WHEN SUPPLY EXHAUSTED USE BM97FD014-1-2 AT EXTRA COST OF \$45 MUST USE UC55121 WITH BETTERMADE UNIT

# FORD/MERCURY

## AEROSTAR VAN

MODEL YEAR	ENGINE SIZE	A.I. PUMP	STEERING	EVAPORATOR KIT	COMPRESSOR	ENGINE KIT	TOTAL PRICE	NOTES
1997-95	3.0L	WO	STD/PWR	SFFD-25134	UC55121	C-7160	\$895.00	
1994-92	3.0L	WO	STD/PWR	SFFD-25134	UC55121	P-2710 / C-7145	\$900.00	
1996-92	4.0L	WO	STD/PWR	SFFD-25134	UC55122	P-2180 / C-7150	\$870.00	

## FORD SUPER DUTY F-250, F-350, F450, F550

MODEL YEAR	ENGINE SIZE	A.I. PUMP	STEERING	EVAPORATOR KIT	COMPRESSOR	ENGINE KIT	TOTAL PRICE	NOTES
2012-11	6.7L	WO	PWR	BM97FD042R-11	UNIT PACKED		\$2,152.00	4
2012-11	6.2L, 6.8L	WO	PWR	BM97FD021R-11	UNIT PACKED		\$2,107.00	4
2010-09	5.4L,6.8L	WO	PWR	BM97FD021R-09	UNIT PACKED		\$2,150.00	1
2009-08	5.4L,6.8L	WO	PWR	BM97FD021R-08	UNIT PACKED		\$2,150.00	2, 5
2010-08	6.4L	WO	PWR	BM97FD042R-08	UNIT PACKED		\$1,875.00	5
2007-06	5.4L	WO	PWR	BM97FD021R-06	UNIT PACKED		\$1,455.00	3, 5
2007-06	6.8L	WO	PWR	BM97FD022R-06	UNIT PACKED		\$1,461.00	3, 5
2007-05	6.0L	WO	PWR	BM97FD042R-05	UNIT PACKED		\$1,182.00	3, 5
2005	5.4L	WO	PWR	BM97FD021R-05	UNIT PACKED		\$1,455.00	
2005	6.8L	WO	PWR	BM97FD022R-05	UNIT PACKED		\$1,461.00	
2004-02	5.4L	WO	PWR	BM97FD021R-02	UNIT PACKED		\$1,365.00	
2004-02	6.8L	WO	PWR	BM97FD022R-02	UNIT PACKED		\$1,346.00	
2004-03	6.0L	WO	PWR	BM97FD042R	UNIT PACKED		\$1,182.00	
2002	7.3L	WO	PWR	BM97FD023R-02	UNIT PACKED		\$1,182.00	
2001-00	5.4L	WO	PWR	BM97FD021R	UNIT PACKED		\$1,365.00	
2001-00	6.8L	WO	PWR	BM97FD022R	UNIT PACKED		\$1,346.00	
2001-00	7.3L	WO	PWR	BM97FD023R	UNIT PACKED		\$1,182.00	
1999	5.4L	WO	PWR	BM97FD021R-99	UNIT PACKED		\$1,346.00	
1999	6.8L	WO	PWR	BM97FD022R-99	UNIT PACKED		\$1,461.00	
1999	7.3L	WO	PWR	BM97FD023R-99	UNIT PACKED		\$1,182.00	

1) AFTER 09/08

2) ALL 5.4, 6.8L NEW BODY STYLE BEFORE 09/08

3) OLD BODY STYLE

4) NEW BODY STARTED NOV 2010

5) COULD BE 2007 OR 2008 BODY STYLE --2008 STYLE HAS CHROME VENT ON FENDER

## F650, F750

MODEL YEAR	ENGINE SIZE	A.I. PUMP	STEERING	EVAPORATOR KIT	COMPRESSOR	ENGINE KIT	TOTAL PRICE	NOTES
2010-08	6.7L	WO	PWR	BM97FD079	UNIT PACKED		\$1,620.00	
2007-06	5.9L	WO	PWR	BM97FD069	UNIT PACKED		\$1,620.00	
2007-04	6.0L	WO	PWR	BM97FD070	UNIT PACKED		\$1,800.00	
2005-04	5.9L	WO	PWR	BM97FD033	UNIT PACKED		\$1,620.00	
2007-04	7.2L	WO	PWR	BM97FD045	TRUCK		\$1,620.00	
2007-04	7.2L	WO	PWR	BM97FD046	TRUCK		\$1,620.00	
2003-00	5.9L	WO	PWR	BM97FD027	UNIT PACKED		\$1,620.00	
2003-00	7.2L	WO	PWR	BM97FD028	UNIT PACKED		\$1,620.00	
2003-00	7.3L	WO	PWR	BM97FD029	UNIT PACKED		\$1,620.00	



# FORD/MERCURY

## PICKUP & BRONCO F-150, F-250, F-350

MODEL YEAR	ENGINE SIZE	A.I. PUMP	STEERING	EVAPORATOR KIT	COMPRESSOR	ENGINE KIT	TOTAL PRICE	NOTES
2009-07	4.2L	W/WO	PWR	BM97FD057R-07	UNIT PACKED WITH DROP IN COIL		\$1,460.00	
2009-07	4.6L,5.4L	W/WO	PWR	BM97FD058R-07	F-150 1/2 TON ONLY-UNIT PACKED		\$1,460.00	22
2006-04	4.2L	W/WO	PWR	BM97FD057R	UNIT PACKED		\$1,360.00	19,20
2006-04	4.6L,5.4L	W/WO	PWR	BM97FD058R	F-150 1/2 TON ONLY-UNIT PACKED		\$1,360.00	19,20,22
2004-97	4.2L	W/WO	PWR	V69014	UNIT PACKED		\$1,375.00	12,14,15 18
2004-97	4.6L 5.4L	W/WO	PWR	V69016R	F-150 1/2 TON ONLY-UNIT PACKED		\$1,375.00	14,15,17 18,21,22
1998-92	5.0L 5.8L 7.3L 7.5L	W/WO	STD/PWR	BM97FD048-1-2	UC4628	C-7131	\$1,410.00	1,8,16
1998-94	7.3L W/8 GRV	WO	PWR	BM97FD048-1-2	UC55121	C-7154	\$1,500.00	1,8,14,16
1996-92	4.9L	W/WO	STD/PWR	BM97FD048-1-3	UC4628	C-7129	\$1,430.00	1,2,16
1991-90	5.0L 5.8L 7.5L	W/WO	STD/PWR	BM97FD047-1-2	UC4628	C-7131	\$1,330.00	1,3
1991-90	4.9L	W/WO	STD/PWR	BM97FD047-1-3	UC4628	C-7129	\$1,425.00	1,2
1991-90	6.9L 7.3L	WO	STD/PWR	BM97FD047-1-2	UC55321	C-7075	\$1,680.00	1,13
1989-88	5.0L 5.8L 7.5L	W/WO	STD/PWR	BM97FD047-1-2	UC4628	C-7116	\$1,400.00	1
1989-87	4.9L	W/WO	STD/PWR	BM97FD047-1-3	UC4628	C-7114	\$1,455.00	1,2,5
1989-87	6.9L 7.3L	WO	STD/PWR	BM97FD047-1-2	UC55321	C-7075	\$1,680.00	1,13
1987	5.0L	W/WO	STD/PWR	BM97FD047-1-2	UC55121	P-0960 / C-7102	\$1,440.00	6
1987	5.8L	W/WO	STD/PWR	BM97FD047-1-2	UC55021	C-7079	\$1,730.00	6
1987	7.5L	W/WO	PWR	BM97FD047-1-2	UC55021	C-7098	\$1,570.00	6
1986-80	4.9L	W	STD/PWR	BM97FD066-1-2	UC55021	C-7083	\$1,745.00	7
1986-85	5.0L 5.8L	W/WO	STD/PWR	BM97FD066-1-2	UC55021	C-7079	\$1,815.00	7
1986-85	7.5L	W/WO	STD/PWR	BM97FD066-1-2	UC55021	C-7098	\$1,650.00	7
1986-83	6.9L	WO	STD/PWR	BM97FD066-1-2	UC55321	C-7075	\$1,760.00	7
1985-83	7.5L	W/WO	STD/PWR	BM97FD066-1-2	UC55021	C-7085	\$1,790.00	7
1984-80	5.0L 5.8L	W/WO	STD/PWR	BM97FD066-1-2	UC55021	C-7063	\$1,785.00	7,10,11
1979-73	CALL ON MOUNT AVAILABILITY			SMFD-739 SM1-4BK44-1420	UC55021	1980-75 460 C-7003	\$1,279.00	9,4
1977-66	BRONCO 302 V8			AM13232-77008	UNIT PACKED		\$1,500.00	23
1972-67	5.0L 5.8L	W/WO	STD/PWR	SMFD690 SM1-4BK44-1420	UC55021	C-7063	\$1,340.00	9
1972-67	360,390	W/WO	STD/PWR	SMFD690 SM1-4BK44-1420	UC55021	C-7273	\$1,420.00	9

1) SWITCH INCLUDED

2) FAN SHROUD 85-2594 \$76.00 NOT INCLUDED IN TOTAL PRICE

3) SOME APPLICATIONS HAVE HD ALT, ORDER C-7130 OR P-1960

4) 1979-73 FORD P/U SELL AM13277-K W/ APPROPRIATE MOUNT &amp; COMPRESSOR FOR COMPLETE KIT

5) SOME APPLICATIONS HAVE HD ALT ORDER C-7115 OR P-1180, FOR EAR MOUNT COMP USE P-0910

6) ORDER #BM9100074 SWITCH FOR 87-88.5 MODELS \$76

7) SWITCH PLATE FOR DUAL TANKS OR BRONCO NO LONGER AVAIL. - MODIFICATION OF PLATE SUPPLIED IN KIT IS REQUIRED

8) EARLY 92 TRUCKS W/7.3L DIESEL USE UC55321 AND P-2411 MOUNT. LATE 94-98 W/8 GRV 7.3L W/D.I. USE P-3700 MOUNT

9) FITS 78-79 BRONCO

10) IF YOU HAVE A CLEVELAND OR MODIFIED ENGINE ORDER C-7005

11) DOES NOT FIT 80 BRONCO

12) FOR TRUCK WITH PRODUCTION DATE 6-24-96 AND EARLIER IN NORFOLK, VA AND PRODUCTION DATE 8-12-96 AND EARLIER IN KANSAS CITY, KS YOU MUST PURCHASE A BELT LOCALLY

13) EXTENSION TUBES ON CONDENSER MUST BE MODIFIED TO FIT WIDE RADIATOR IF USING CM2092

14) WIRES TO PRESSURE CYCLING SWITCH MUST BE EXTENDED FOR '98 AND EARLIER MODELS

15) WILL FIT 2004 HERITAGE F150 WITH WIRING MODIFICATION

16) FOR 94.5 W/7GRV USE C-7158

17) ON MODELS WITH 6 GROOVE BELT ORDER BELT LOCALLY NOT INCLUDED

18) IN 2004 FITS HERITAGE TRUCK ONLY

19) DOES NOT FIT 2004 HERITAGE F150

20) PRODUCTION DATES THROUGH 11/28/04 USE THE 4L3Z CONTROL HEAD, 11/29/04 AND UP USE THE 7L3Z CONTROL HEAD

21) USE BM97FD015-1-2 WHEN V69016R IS DEPLETED \$1182

22) ONLY FOR F150 1/2 TON TRUCK. FOR 1999-2012 F250 F350 F450 F550 SUPER DUTY SEE PAGE 768

23) HD 17" FAN BLADE REQUIRED. AM430-255 \$88.00 FOR 1999-2012- F250 F350 F450 F550 SUPERDUTY SEE PAGE 768

# FORD/MERCURY

## F600 - 900

MODEL YEAR	ENGINE SIZE	A.I. PUMP	STEERING	EVAPORATOR KIT	COMPRESSOR	ENGINE KIT	TOTAL PRICE	NOTES
1998-93	8.3L	WO	PWR	BM97FD066-1-2	UC55121	P-4381	\$1,572.00	1,3
1998-93	5.9L	WO	PWR	BM97FD066-1-2	UC55121	C-5168	\$1,540.00	1,2,3
1998-94	7.0L	W/WO	PWR	BM97FD066-1-2	UC55021	C-5281	\$1,465.00	3
1994-92	6.6L 7.8L DIESEL	WO	PWR	BM97FD066-1-2	UC55063	C-5133	\$1,565.00	1,3
1991-87	6.6L 7.8L DIESEL	WO	STD/PWR	BM97FD066-1-2	UC55021	C-5095	\$1,600.00	1,3
1993-85	370 429 GAS	W	PWR	BM97FD066-1-2	UC55021	C-5098	\$1,465.00	1,3

- 1) DOES NOT FIT TRUCKS WITH DASH VENTS.  
 2) W/O AIR BRAKES  
 3) CONTROL PLATE MODIFICATION MAY BE REQUIRED

## RANGER/EXPLORER/BRONCO II

MODEL YEAR	ENGINE SIZE	A.I. PUMP	STEERING	EVAPORATOR KIT	COMPRESSOR	ENGINE KIT	TOTAL PRICE	NOTES
2011-07	2.3L	WO	PWR	BM97FD016R-07	UNIT PACKED		\$1,750.00	O.E. PARTS, 11,12
2010-07	2.3L	WO	PWR	BM97FD075-1-2 BM9100088 & 89	UC52038	P-5450/C-7156	\$1,870.00	7,10,11
2010-07	3.0L	WO	PWR	BM97FD077-1-2	UC52038	C-7180	\$1,450.00	
2010-07	4.0L	WO	PWR	BM97FD078-1-2	UC55122	C-7150	\$1,460.00	
2006-04	2.3L	WO	PWR	BM97FD037-1-2	UC52038	P-5450/C-7156	\$1,630.00	11
2006-04	3.0L	WO	PWR	BM97FD035-1-2	UC55121	C-7150	\$1,490.00	
2006-04	4.0L	WO	PWR	BM97FD035-1-2	UC55122	C-7150	\$1,490.00	
2003-98	4.0L	WO	PWR	BM97FD016-1-2	UC55122	P-5360	\$1,583.00	9
2003-98	3.0L	WO	PWR	BM97FD016-1-2	UC55121	C-7150	\$1,480.00	9
2003-98	2.5L	WO	STD	BM97FD016-1-2	UC55121	C-7156	\$1,575.00	6,7,9
2003-98	2.5L	WO	PWR	BM97FD016-1-2	UC55121	C-7159	\$1,460.00	6,7,9
2003-01	2.3L	WO	PWR	BM97FD030-1-2 BM9100088 & 89	UN45088	C-7174	\$1,615.00	11
1997-95	2.3L	WO	PWR	BM97FD011-1-2	UC55121	C-7159	\$1,415.00	1,7,8
1997-95	2.3L	WO	STD	BM97FD011-1-2	UC55121	P-3790 / C-7156	\$1,530.00	1,7,8
1997-95	3.0L	WO	PWR	BM97FD011-1-2	UC55121	C-7171	\$1,440.00	7,8
1997-95	4.0L	WO	PWR	BM97FD011-1-2	UC55122	P-2180 / C-7138	\$1,435.00	7,8
1994-92	2.3L	WO	PWR	BM97FD007-1-2	UC55121	C-7142	\$1,400.00	1,3
1994-92	2.3L	WO	STD	BM97FD007-1-2	UC55121	P-2590 / C-7143	\$1,500.00	1,3
1994-92	3.0L	WO	PWR	BM97FD007-1-2	UC55121	C-7171	\$1,450.00	3
1994-90	4.0L	WO	PWR	BM97FD007-1-2	UC55122	C-7138	\$1,440.00	3
1994-89	2.9L	WO	PWR	BM97FD007-1-2	UC55021	C-7089	\$1,515.00	2,3
1988-86	2.9L	WO	PWR	BM97FD001-1-2	UC55021	C-7089	\$1,515.00	2
1988-85	2.3L	WO	STD/PWR	BM97FD001-1-2	UC55121	C-7119	\$1,490.00	1,2
1988-83	2.0L	W	STD/PWR	BM97FD001-1-2	UC55121	C-7071	\$1,660.00	1
1985-83	2.8L	WO	STD/PWR	BM97FD001-1-2	UC55021	C-7087	\$1,625.00	4,5

- 1) FAN SHROUD 13-0329 OR CM3800701-17 \$58.00 REQUIRED WHEN NOT EQUIPPED FROM FACTORY - NOT INCLUDED IN TOTAL PRICE  
 2) 1988-82 REQUIRE FAN SHROUD BM9100052 \$100  
 3) IN 92-94 SOME MODELS BUILT WITHOUT GREEN WIRE AT OEM 8 PIN CONNECTOR IN KICK PANEL ORDER BM9100058 \$76  
 4) FOR MODELS WITHOUT FRESH AIR DOOR UNIT WILL NOT WORK AS WELL  
 5) OPTIONAL FAN SHROUD 14-8603 \$41.00  
 6) ORDER FAN SHROUD FROM DEALER IF NOT EQUIPPED  
 7) 1997.5 NEED WIRING HARNESS BM9100060 \$74  
 8) USE MODE SWITCH PROVIDED IN KIT  
 9) 1998-99 IF VEHICLE IS EQUIPPED WITH O.E. WIRING (PRESSURE CYCLING SWITCH PLUG PRESENT) ORDER BM9100064 \$70  
 10) SELL "RANGER INSTRUCT" FOR 2006 AND UP RANGER UNITS  
 11) 98-08 RANGER 2.3L CAN USE A CUSTOM AIR UNIT /98FR452-1, /98FR452-5, 14-2732NC, V3-599 X 4 , 6K-837 \$1336.0C  
 12) BM97FD016R-07 HAS \$125-00 GROUND SHIPPING \*\*\*\*\*HEAVY FREIGHT\*\*\*\*\*

# FORD/MERCURY

## ECONOLINE VAN

MODEL YEAR	ENGINE SIZE	A.I. PUMP	STEERING	EVAPORATOR KIT	COMPRESSOR	ENGINE KIT	TOTAL PRICE	NOTES
2009-04	6.0L DIESEL	WO	PWR	BM97FD090R	UNIT PACKED		\$1,360.00	2
2007-97	4.2L	WO	PWR	BM97FD024R	UNIT PACKED		\$1,230.00	2
2010-97	4.6L 5.4L 6.8L	WO	PWR	BM97FD019R	UNIT PACKED		\$1,400.00	2
2004-97	7.3L DIESEL	WO	PWR	BM97FD025R	UNIT PACKED		\$1,230.00	2
1996-92	4.9L	W/WO	STD/PWR	CM2108**	UC4628	C-7129	\$955.00	1,2
1996-92	5.0L 5.8L 7.3L 7.5L	W/WO	STD/PWR	CM2108**	UC4628	C-7131	\$890.00	2,4
1991-90	4.9L	W	PWR	CM2125**	UC4628	C-7129	\$950.00	2,3
1991-90	4.9L HD ALT	W	PWR	CM2125**	UC4628	P-1960 / C-7130	\$1,200.00	2,3
1991-90	5.0L 5.8L 7.5L	W	PWR	CM2125**	UC4628	C-7131	\$1,144.00	2,3
1990-88	6.9L 7.3L DIESEL	WO	STD/PWR	CM2125**	UC55321	C-7075	\$1,259.00	3
1989-88	4.9L	W	STD/PWR	CM2125**	UC4628	C-7114	\$1,209.00	2,3,
1989-88	4.9L HD ALT	W	STD/PWR	CM2125**	UC4628	P-1180 / C-7115	\$1,209.00	2,3
1989-88	5.0L 5.8L 7.5L	W	STD/PWR	CM2125**	UC4628	C-7116	\$1,154.00	2,3
1987	4.9L	W	PWR	SMFD-752	UC4628	C-7114	\$1,429.00	
1987	4.9L HD ALT	W	PWR	SMFD-752	UC4628	P-1180 / C-7115	\$1,402.00	
1987	5.0L	W	STD/PWR	SMFD-752	UC55121	P-0960 / C-7102	\$1,367.00	
1987	351 CID	W/WO	STD/PWR	SMFD-752	UC55021	C-7063	\$1,559.00	
1987-85	460 CID	W/ DUAL	STD/PWR	SMFD-752	UC55021	C-7098	\$1,464.00	
1987-83	6.9L 7.3L	WO	PWR	SMFD-752	UC55321	C-7075	\$1,479.00	
1986-81	300 CID	W/WO	STD/PWR	SMFD-752	UC55021	C-7083	\$1,529.00	
1986-75	302 CID	W/WO	STD/PWR	SMFD-752	UC55021	C-7063	\$1,559.00	
1985-83	460 CID	W/WO	STD/PWR	SMFD-752	UC55021	C-7085	\$1,564.00	
1980-75	460 CID	W/WO	STD/PWR	SMFD-752	UC55021	C-7003	\$1,564.00	

1) HD ALT REQUIRES P-1960 / C-7130 MOUNT

2) FACTORY COIL, ACCUMULATOR &amp; CONDENSER

3) IN SHORT SUPPLY, USE AM13212 + AM MOUNT WHEN SUPPLY EXHAUSTED

4) W/ 8 GROOVE ORDER P-3700 W/ UC55121

\*\* CALL FIRST SHORT SUPPLY

## LN SERIES

MODEL YEAR	ENGINE SIZE	A.I. PUMP	STEERING	EVAPORATOR KIT	COMPRESSOR	ENGINE KIT	TOTAL PRICE	NOTES
2000-99	3126 CAT 7.2L	WO	PWR	AM13500	AM5151-K		\$1,378.00	1,3
2000-99	5.9L	WO	PWR	AM13500	AM45004980-K		\$1,397.00	1,3
1998-96	5.9L	WO	PWR	AM13222	AM45004980-K		\$1,439.00	1,3
1999-96	8.3L	WO	PWR	AM13222	AM45003840-K		\$1,420.00	1,3
1998-96	10.0L	WO	PWR	AM13222	VARIOUS	VARIOUS	\$1,300.00	1,3
1998-96	11.0L	WO	PWR	AM13222	AM45004080-K		\$1,420.00	1,3
1995-94	8.3L	WO	PWR	AM13222	AM45002971		\$1,338.00	1,2
1995-94	4BT - 6BT	WO	PWR	AM13222	AM45003900		\$1,400.00	1,2
1992-91	7.8L	WO	PWR	AM13222	AM45001700R-K		\$1,348.00	1,2
1991-84	3406 CAT	WO	PWR	AM13218	AM5089		\$1,350.00	2
1991-87	7.8L	WO	PWR	AM13218	AM6332		\$1,384.00	2

1) WITH LOUVERS IN DASH &amp; DROP-IN COIL

2) OTHER MOUNTS AVAILABLE

3) LET US KNOW ENGINE EQUIPMENT, SIZE, PULLEYS, AND COMPRESSOR SIDE TO GET PROPER MOUNT &amp; COMPRESSOR

# FORD/MERCURY

## CARGO SERIES

MODEL YEAR	ENGINE SIZE	A.I. PUMP	STEERING	EVAPORATOR KIT	COMPRESSOR	ENGINE KIT	TOTAL PRICE	NOTES
2000-99	5.9L '1060'	WO	PWR	AM13224	AM45003961-K		\$1,398.00	
1998-93	8.3L	WO	PWR	AM13224	AM77014		\$1,453.00	1
1995-92	5.9L '1060'	WO	PWR	AM13224	AM7148		\$1,274.00	1
1991-87	7.8L	WO	PWR	AM13224	AM5095		\$1,366.00	1

1) OTHER MOUNTS AVAILABLE

# GENERAL MOTORS

## AVEO

MODEL YEAR	ENGINE SIZE	A.I. PUMP	STEERING	EVAPORATOR KIT	COMPRESSOR	ENGINE KIT	TOTAL PRICE	NOTES
2011-09	1.6L	WO	PWR	AVEO-2009	UNIT PACKED		\$1,645.00	1,4
2011-09	1.6L	WO	PWR	BM97GM045-1-2	UNIT PACKED		\$1,965.00	4
2008-05	1.6L	WO	PWR	AVEO	UNIT PACKED		\$1,800.00	1,4
2008-04	1.6L	WO	PWR	BM97GM023-1-2	UC55121	C-4334	\$1,559.00	2, 3

1) FACTORY KIT 2) FOR CARS WITHOUT A/C PREP

3) 2008 SEDAN WILL USE THE 2004 UNIT W/O FACTORY PREP BE SURE TO SEND 2007 WIRING DIAGRAM

2008 HATCHBACK WITH (C66) DEALER PREP PACKAGE USES 2006-05 UNIT FOR CARS WITH FACTORY A/C PREP GET VIN TO CONFIRM WITH DEALER OR CHECK TAG ON SPARE TIRE COVER OR IN GLOVEBOX FOR OPTION (C66)

4) ONLY FOR VEHICLE EQUIPPED W/ FACTORY PREP PACKAGE (OPTION CODE C66)  
COMPUTER NEEDS TO BE RE-PROGRAMMED BY THE DEALER

## BERETTA/CORSICA

MODEL YEAR	ENGINE SIZE	A.I. PUMP	STEERING	EVAPORATOR KIT	COMPRESSOR	ENGINE KIT	TOTAL PRICE	NOTES
1996-95	2.2L	WO	PWR	SFGM-53934	UC55121	P-3760	\$937.00	1
1994-92	2.2L	WO	PWR	SFGM-53934	UC55121	P-1711 / C-4226	\$924.00	
1993-92	3.1L	WO	PWR	SFGM-53934	UC55121	C-4254	\$855.00	

1) SOME WIRING MODIFICATIONS REQUIRED ON '96

## CAMARO

MODEL YEAR	ENGINE SIZE	A.I. PUMP	STEERING	EVAPORATOR KIT	COMPRESSOR	ENGINE KIT	TOTAL PRICE	NOTES
1997-96	3.8L	W/WO	STD/PWR	SF30-0154	UC55121	C-4290	\$695.00	1

1) ONE LEFT AT TIME OF PRINTING

## CAVALIER/SUNFIRE

MODEL YEAR	ENGINE SIZE	A.I. PUMP	STEERING	EVAPORATOR KIT	COMPRESSOR	ENGINE KIT	TOTAL PRICE	NOTES
2001-98	2.2L	WO	PWR	SMCH-985	UNIT PACKED		\$725.00	1
1997-93	2.4L	WO	PWR	CM2042-03	UC55121	P-4050	\$740.00	1
1997-95	2.2L	WO	PWR	SMCH-985	UNIT PACKED		\$725.00	1
1994-90	2.2L	WO	PWR	SF30-0003	UC55121	P-1711	\$1,300.00	

1)ADD FROM DEALER OEM FAN, OEM FAN MOTOR, AND OEM SHROUD

## COBALT

MODEL YEAR	ENGINE SIZE	A.I. PUMP	STEERING	EVAPORATOR KIT	COMPRESSOR	ENGINE KIT	TOTAL PRICE	NOTES
2010-08	4 CYL	WO	PWR	BM97GM047	UNIT PACKED		\$1,800.00	1
2007-05				CALL				

1) COMPUTER MAY NEED TO BE FLASHED AT THE DEALER

## METRO

MODEL YEAR	ENGINE SIZE	A.I. PUMP	STEERING	EVAPORATOR KIT	COMPRESSOR	ENGINE KIT	TOTAL PRICE	NOTES
2002-95	1.0L	WO	STD	BM97GM017-1-2	UC52080	C-4275	\$1,700.00	1, 2
2002-95	1.3L	WO	STD	BM97GM017-1-2	UC52080	P-5010 / C-4277	\$1,650.00	1, 2
2001-95	1.3L	WO	PWR	BM97GM017-1-2	UC52080	P-3661 / C-4278	\$1,680.00	1, 2
1994-92	1.0L	WO	STD	BM97GM016-1-2	UC52080	C-4257	\$1,700.00	1, 2

1) OPTIONAL IDLE UP BM9100067 \$97

3) ALSO MUST ORDER 9100069 RELAY FOR 98-02 \$48

# GENERAL MOTORS

## PRIZM

MODEL YEAR	ENGINE SIZE	A.I. PUMP	STEERING	EVAPORATOR KIT	COMPRESSOR	ENGINE KIT	TOTAL PRICE	NOTES
2000-98	1.8L	WO	PWR	CM2072-00	UC52114	P-4530	\$1,032.00	
1997-93	1.6L 1.8L	WO	STD/PWR	CM2008-00	UC55121	C-2044	\$740.00	1

## STORM

MODEL YEAR	ENGINE SIZE	A.I. PUMP	STEERING	EVAPORATOR KIT	COMPRESSOR	ENGINE KIT	TOTAL PRICE	NOTES
1993-90	1.6L	WO	STD/PWR	CM2840	UC55121	P-2060 / C-4225	\$874.00	1,2
1993-90	1.8L DOHC	WO	STD/PWR	CM2840	UC55121	P-2930 / C-4255	\$867.00	1,2

- 1) ONE LEFT AT PRINTING TIME  
2) DOES NOT FIT 1.6L 16VLV ENGINE

## TRACKER

MODEL YEAR	ENGINE SIZE	A.I. PUMP	STEERING	EVAPORATOR KIT	COMPRESSOR	ENGINE KIT	TOTAL PRICE	NOTES
1998-93	1.6L 16 VLV	WO	PWR	BM97GM009-1-2	UC52080	C-4294	\$1,192.00	
1998-93	1.6L 16 VLV	WO	STD	BM97GM009-1-2	UC52080	P-3361 / C-4296	\$1,158.00	
1998-91	1.6L	WO	PWR	BM97GM009-1-2	UC52080	P-4760 / C-4284	\$1,185.00	
1998-91	1.6L	WO	STD	BM97GM009-1-2	UC52080	C-4285	\$1,207.00	

## S-10 PICKUP & BLAZER / GMC S-15 PICKUP, JIMMY & SONOMA

MODEL YEAR	ENGINE SIZE	A.I. PUMP	STEERING	EVAPORATOR KIT	COMPRESSOR	ENGINE KIT	TOTAL PRICE	NOTES
2003-98	4.3L	W/WO	STD/PWR	BM97GM012-1-2	UC55122	C-4286	\$1,225.00	2,7,5
2003-98	2.2L	WO	PWR	BM97GM012-1-2	UC55122	P-4510 / C-4304	\$1,178.00	1,7
1997-96	4.3L	W/WO	STD/PWR	BM97GM008-1-2	UC55122	C-4286	\$1,317.00	2,8
1997-94	2.2L	WO	PWR	BM97GM008-1-2	UC55122	P-3310 / C-4259	\$1,277.00	1
1995-94	4.3L	W/WO	STD/PWR	BM97GM008-1-2	UC55122	C-4219	\$1,313.00	2,5
1993-87	2.5L	WO	STD/PWR	CM2069-00	UC55121	C-4158	\$755.00	3,4
1993-87	2.8L	W	PWR	CM2069-00	UC55321	P-0951	\$780.00	3,4
1993-87	2.8L	W	STD	CM2069-00	UC55321	C-4168	\$915.00	3,4
1993-87	4.3L	W/WO	PWR	CM2069-00	UC55121	P-1630 / C-4193	\$698.00	3,4
1986	2.8L	W	STD/PWR	CM2069-00	UC52310	C-4157	\$835.00	3,4
1986	2.5L	WO	STD/PWR	CM2069-00	UC55021	C-4173	\$855.00	3,4
1985	2.8L W/4 GROOVE POLY V ALT	W	STD/PWR	AM14308-K		AM4157-K	\$1,482.00	6
1985-82	2.8L	W	STD/PWR	AM14308-K		AM4073-K	\$1,450.00	6
1985-82	2.0L 1.9L	W/WO	STD/PWR	AM14308-K		CALL FOR AVAILABILITY	\$1,400.00	

- 1) O.E. TYPE FAN/CLUTCH REQUIRED FOR 4 CYL MODELS WITH 3 BLADE COOLING FAN, BUY FROM DEALER  
2) O.E. TYPE FAN/CLUTCH REQUIRED FOR 6 CYL MODELS WITH 3 BLADE COOLING FAN, BUY FROM DEALER  
3) FOR EXTRA COOLING ORDER FAN & CLUTCH FROM DEALER  
4) FOR S-10 W/O LOUVERS ORDER SF70-6435 ADD \$95.50 TO TOTAL PRICE  
5) CALL ON HARRISON AVAILABILITY 2003-98 S10 4.3L V6 HARRISON UNIT SFGM-55334 \$1400.00 \*\*\*\*SEE NOTE\*\*\*\*\*  
6) ORDER KIT AM14310-K FOR TRUCKS WITHOUT LOUVERS ADD \$40  
8) ORDER 13-0841 WIRING UPDATE FOR 97 ONLY \$3.00

## S-10 PICKUP & BLAZER / GMC S-15 PICKUP, JIMMY & SONOMA \* HARRISON UNIT \*

MODEL YEAR	ENGINE SIZE	A.I. PUMP	STEERING	EVAPORATOR KIT	COMPRESSOR	ENGINE KIT	TOTAL PRICE	NOTES
2003-98	4.3L	W/WO	STD/PWR	SFGM-55334	UNIT PACKED		\$1,150.00	1,2

- 1) O.E. TYPE FAN/CLUTCH REQUIRED FOR 6 CYL MODELS WITH 3 BLADE COOLING FAN, ORDER FROM DEALER  
2) LIMITED SUPPLY, CALL

# GENERAL MOTORS

## CHEVROLET & GMC PICKUP

MODEL YEAR	ENGINE SIZE	A.I. PUMP	STEERING	EVAPORATOR KIT	COMPRESSOR	ENGINE KIT	TOTAL PRICE	NOTES
2013-10	4.8,5.3,6.0L V8	WO	PWR	BM97GM050-1-2	14-21127		\$1,975.00	19
2009-07	4.3L V6	WO	PWR	BM97GM026-1-2	UC56121	C-4321	\$1,700.00	14
2009-07	4.8,5.3,6.0L V8	WO	PWR	BM97GM027-1-2	UC56121	C-4316	\$2,060.00	
2009-07	6.6 DIESEL	WO	PWR	BM97GM032-1-2	UC56121	C-4332	\$2,290.00	
2006-03	4.3	WO	PWR	BM97GM020-1-2	14-DK55121NC	C-4286	\$1,440.00	15
2006-03	4.8,5.3,6.0L V8	WO	PWR	BM97GM020-1-2	UC56121	C-4316	\$1,520.00	15
2006-03	6.6 DIESEL	WO	PWR	BM97GM020-1-2	UC56121	P-5350 / C-4332	\$1,440.00	14,15
2002-01	6.6 DIESEL	WO	PWR	BM97GM020-1-2	UC56121	P-5350 / C-4332	\$1,410.00	17
2002-01	8.1	WO	PWR	BM97GM020-1-2	UC56121	P-5320 / C-4328	\$1,450.00	17
2002-99	6 CYL	WO	PWR	BM97GM020-1-2	14-DK55121NC	C-4286	\$1,400.00	13,17
2002-99	4.8,5.3,6.0L V8	WO	PWR	BM97GM020-1-2	UC56121	C-4316	\$1,490.00	13,17
1998-96	4.3L 5.0L 5.7L	WO	STD/PWR	BM97GM007-1-2	14-DK55121NC	C-4286	\$1,525.00	1,8,10,12
1998-96	7.4L	WO	STD/PWR	BM97GM007-1-2	UC55121	C-4292	\$1,540.00	9,10
1998-96	6.5L	WO	PWR	BM97GM007-1-2	UC55122	P-4710 / C-4291	\$1,575.00	10,11
1995	7.4L	WO	PWR	BM97GM007-1-2	UC55121	P-3830 / C-4262	\$1,625.00	
1995	6.5L	WO	PWR	BM97GM007-1-2	UC55121	C-4184	\$1,555.00	9,10
1995	4.3L 5.0L 5.7L	WO	STD/PWR	BM97GM007-1-2	UC55121	C-4219	\$1,485.00	2,8,9,10
1995	4.3L 5.0L 5.7L	W	STD/PWR	BM97GM007-1-2	UC55121	C-4220	\$1,485.00	2,8,9,10
1994-92	6.5L	WO	PWR	BM97GM003-1-2	UC55121	C-4184	\$1,555.00	9,10
1994-90	4.3L 5.0L 5.7L	WO	STD/PWR	BM97GM003-1-2	UC55121	C-4219	\$1,485.00	2,8,9,10
1994-90	4.3L 5.0L 5.7L	W	STD/PWR	BM97GM003-1-2	UC55121	C-4220	\$1,485.00	2,8,9,10
1994	7.4L	WO	PWR	BM97GM003-1-2	UC55121	P-3830 / C-4262	\$1,625.00	
1994-90	4.3L 5.0L 5.7L	W	STD/PWR	BM97GM003-1-2	UC55121	P-1910 / C-4195	\$1,500.00	2,9,10
1993-90	7.4L	WO	STD/PWR	BM97GM003-1-2	UC55121	C-4242	\$1,520.00	2,9,10
1989-88	4.3L 5.0L 5.7L	W/WO	STD/PWR	BM97GM003-1-2	UC55021	C-4201	\$1,805.00	2,9,10
1989-88	6.2L	WO	STD/PWR	BM97GM003-1-2	UC55121	C-4184	\$1,555.00	1,2,9,10
1989-88	7.4L	WO	STD/PWR	BM97GM003-1-2	UC55121	C-4181	\$1,530.00	2,9,10
1987-86	5.0L 5.7L	W/WO	STD/PWR	BM97GM011-1-2	UC55021	C-4143	\$1,801.00	3,4,6,7,18
1985-83	262-400	W/WO	STD/PWR	BM97GM011-1-2	UC55021	C-4055	\$1,850.00	3,4,6,7,18
1982-81	262-400	W/WO	STD/PWR	BM97GM011-1-2	UC55021	C-4055	\$1,850.00	4,6,7,18
1980-73	262-400	W/WO	STD/PWR	BM97GM001-1-2	UC55021	C-4055	\$1,610.00	5,6,7
1972-67	327-350	WO	STD/PWR	AM14315-4197	UNIT PACKED		\$1,690.00	6

- 1) MAY NEED TO AD ELECTRIC VACUUM PUMP IF VEHICLE IS NOT FACTORY EQUIPPED
- 2) DOES NOT WORK IN TRUCKS WITHOUT FACTORY DASH LOUVERS.
- 3) INTEGRATED SWITCHING
- 4) CURVED LOUVER COMES IN KIT INCLUDED IN TOTAL PRICE
- 5) STRAIGHT LOUVER COMES IN KIT INCLUDED IN TOTAL PRICE
- 6) OTHER ENGINE MOUNTS AVAILABLE, PLEASE CALL. DUAL ALT 6.2L MOUNTS NOW AVAILABLE
- 7) SWITCH IN LOUVER
- 8) ORDER O.E FAN FROM DEALER IF NOT EQUIPPED WITH HD COOLING - NOT INCLUDED IN TOTAL PRICE
- 9) IF THE VEHICLE IS A CREW CAB, BLAZER, OR SUBURBAN SEE FOLLOWING SECTION
- 10) FITS 2000-99 OLD BODY STYLE TRUCK, 2001-95 CAN USE AR0508511 WITH AR0571528, 1994-88 AR0508511 AR0571527
- 11) IF 124 AMP ALT ORDER P-4720 / C-4298
- 12) IF 124 AMP ALT ORDER P-4600 / C-4299
- 13) NEW BODY STYLE (GRAB BAR OVER GLOVE BOX)
- 14) HARRISON UNIT AVAILABLE AND STRONGLY SUGGESTED SMCH994-01 FOR 2009-01
- 15) BM9100095 NEEDED FOR 2005-06 APPLICATIONS IF TRUCK IS EQUIPPED WITH ELECTRIC FANS \$116
- 16) USE 2006 PARTS FOR 2007 CLASSIC SILVERADO. CLASSIC SILVERADO HAS GRAB BAR IN GLOVE BOX AREA
- 17) AR0508542 KIT IS AVAILABLE AT A HUGE SAVINGS SEE APPENDIX C V6 ADD AR0571576 C-4286 14-DK55121  
V8 ADD AR0571575 C4316 14-DK55121
- 18) FOR OLD BODY TRUCKS WITH WING WINDOW ON EACH FRONT DOOR.
- 19) MOSTLY FACTORY PARTS(i.e. COMPRESSOR, ACCUMULATOR, HOSES, CONTROLS)

# GENERAL MOTORS

## CHEVROLET & GMC C-10 \* HARRISON UNIT \*

MODEL YEAR	ENGINE SIZE	A.I. PUMP	STEERING	EVAPORATOR KIT	COMPRESSOR	ENGINE KIT	TOTAL PRICE	NOTES
2009-07	V6	WO	PWR	SMCH994-01	UNIT PACKED		\$2,370.00	4,6,7
2009-07	V8	WO	PWR	SMCH994-02	UNIT PACKED		\$2,472.00	4,7
1995	5.0L	WO	PWR	SMCH970	UNIT PACKED		\$1,400.00	7
1994-88	5.0L	USE SMCH952-1 PLUS MOUNT AND COMPRESSOR					CALL	1, 3, 5,7

- 1) FITS TRUCKS WITH PLASTIC GLOVE BOX DOOR ONLY. MUST KNOW ENGINE SIZE
- 2) 2005-06 TRUCKS EQUIPPED WITH ELECTRIC FANS FROM FACTORY. THE ENGINE COMPUTER TURNS THEM ON WITH A/C.
- 3) SMCH950 IS USED TO ADD LOUVERS TO 88-92 TRUCKS \$121
- 4) USE 2006 PARTS FOR 2007 CLASSIC SILVERADO. CLASSIC SILVERADO HAS A GRAB BAR IN GLOVE BOX AREA
- 5) MOUNTS AND COMPRESSORS ARE AVAILABLE FOR ANY 88-94 TRUCK THAT DOES NOT HAVE A FACTORY R 4 MOUNT
- 6) SOME 2009-07 MAY NEED TO BE REPROGRAMMED AT THE DEALER
- 7) CALL VERY LIMITED AVAILABILITY

## CHEVROLET SILVERADO HD & GMC SIERRA HD

MODEL YEAR	ENGINE SIZE	A.I. PUMP	STEERING	EVAPORATOR KIT	COMPRESSOR	ENGINE KIT	TOTAL PRICE	NOTES
2013-10	4.8,5.3,6.0L V8	WO	PWR	BM97GM050-1-2	14-21127		\$1,486.00	3
2006-03	8.1L GAS	WO	PWR	SMCH993	SMCH998-IK8.1		\$2,656.00	1
2006-03	6.6 DIESEL	WO	PWR	SMCH993	SMCH998-IK		\$2,203.00	2
2006-03	4.8,5.3,6.0L V8	WO	PWR	SMCH993	SMCH999-IK		\$2,446.00	1

- 1) PARTS NOT SOLD SEPERATELY
- 2) O.E. MANIFOLD REQUIRED - PURCHASE FROM DEALER
- 3) MOSTLY FACTORY PARTS(i.e. COMPRESSOR, ACCUMULATOR, HOSES, CONTROLS)

## CHEVROLET & GMC CREW CAB PICKUP, BLAZER, JIMMY & SUBURBAN

MODEL YEAR	ENGINE SIZE	A.I. PUMP	STEERING	EVAPORATOR KIT	COMPRESSOR	ENGINE KIT	TOTAL PRICE	NOTES
2002-01	V6	WO	PWR	BM97GM020-1-2	UC55121	C-4286	\$1,405.00	
2002-01	V8	WO	PWR	BM97GM020-1-2	UC55121	C-4316	\$1,490.00	
2000-96	7.4L	WO	PWR	BM97GM007-1-2	UC55121	C-4292	\$1,630.00	8
2000-96	6.5L	WO	PWR	BM97GM007-1-2	UC55122	P-4710 / C-4291	\$1,575.00	7,8
2000-96	4.3,5.0,5.7L	WO	PWR	BM97GM007-1-2	UC55121	C-4286	\$1,525.00	5,6,8
1995-92	4.3,5.0,5.7L	WO	PWR	BM97GM007-1-2	UC55121	C-4219	\$1,485.00	4,5
1995	6.5L DIESEL	WO	PWR	BM97GM007-1-2	UC55121	P-3650 / C-4184	\$1,555.00	4
1995	7.4L	WO	PWR	BM97GM007-1-2	UC55121	P-3830 / C-4262	\$1,625.00	4
1994-92	5.0L 5.7L	W	PWR	BM97GM007-1-2	UC55121	P-1910 / C-4195	\$1,505.00	5
1991-90	5.0L 5.7L	WO	STD/PWR	BM97GM011-1-2	UC55121	P-3381 / C-4219	\$1,595.00	1,2,3,9
1991-90	7.4L	W/WO	PWR	BM97GM011-1-2	UC55121	P-2030 / C-4242	\$1,630.00	1,2,9
1991-90	6.2L DIESEL W/VAC PUMP	WO	PWR	BM97GM011-1-2	UC55121	P-3650 / C-4184	\$1,665.00	1,2,9
1989-88	5.0L 5.7L	W/WO	PWR	BM97GM011-1-2	UC55021	P-0873 / C-4201	\$1,920.00	1,2,3,9
1989-88	7.4L	W/WO	PWR	BM97GM011-1-2	UC55121	C-4181	\$1,645.00	1,2,9
1989-88	6.2L	WO	PWR	BM97GM011-1-2	UC55121	P-3650 / C-4184	\$1,665.00	1,2,9
1987-73	HEVROLET PICKUP							10

- 1) CURVED LOUVER COMES IN KIT INCLUDED IN TOTAL PRICE
- 2) INTEGRATED SWITCH KIT NO LONGER AVAILABLE
- 3) SOME MODELS USE OLDER MOUNT, PLEASE INDICATE LOCATION OF ALTERNATOR
- 4) FOR REAR A/C SEE TAHOE PAGE 16
- 5) IF NOT EQUIPPED WITH HD COOLING ORDER LARGE FAN FROM DEALER
- 6) IF EQUIPPED WITH 124 AMP ALT ORDER P-4600 / C-4299
- 7) IF EQUIPPED WITH 124 AMP ALT ORDER P-4720 / C-4298
- 8) TRUCKS WITH NEW BODY STYLE USE SILVERADO A/C ON PREVIOUS PAGE
- 9) FOR OLD BODY TRUCKS WITH WING WINDOW ON EACH FRONT DOOR.
- 10) 1987-81 454 MOUNT IS C-4093



# GENERAL MOTORS

## ASTRO / SAFARI VAN

MODEL YEAR	ENGINE SIZE	A.I. PUMP	STEERING	EVAPORATOR KIT	COMPRESSOR	ENGINE KIT	TOTAL PRICE	NOTES
2002-96	4.3L	WO	PWR	BM97GM039-1-2	UC55122	C-4286	\$1,575.00	4
1995	4.3L	WO	PWR	SF30-0111	UC55122	C-4273	\$1,011.00	3
1994-90	4.3L	WO	PWR	SFGM-54034	UC55122	C-4217	\$1,037.00	2,5
1990-87	2.5L	W/VO	STD/PWR	SFGM-54034	UC55121	C-4158	\$1,012.00	1,5
1989-87	4.3L	W/VO	STD/PWR	SFGM-54034	UC55011	C-4201	\$1,132.00	1,5
1986-85	2.5L	W/VO	STD/PWR	SFGM-54034	UC55021	C-4173	\$1,112.00	1,5
1986-85	4.3L	W/VO	STD/PWR	SFGM-54034	UC55021	C-4129	\$1,022.00	1,5

1) MUST HAVE FACTORY LOUVERS.

2) VORTEX ENGINE TAKES MOUNT P-3600 / C-4273

3) SFGM-54034 WHEN EXISTING SUPPLY IS EXHAUSTED

4) MAY NEED TO MODIFY WIRING ON SOME MODELS OR CHANGE COMPRESSOR SWITCH NOT SUPPLIED IN KIT.

5) SFGM-54034 IS AN R-12 UNIT AN WILL NEED MODIFICATION IF USED FOR R-134A WILL ALSO NEED A PARALLEL FLOW COND.

## G10 G20 G30 VAN

MODEL YEAR	ENGINE SIZE	A.I. PUMP	STEERING	EVAPORATOR KIT	COMPRESSOR	ENGINE KIT	TOTAL PRICE	NOTES
1984-78	5.7L V8	W/VO	STD/PWR	AM14304-4099	UNIT PACKED		\$1,575.00	1

1) SPECIAL ORDER. ONE WEEK LEAD TIME.

## GMT -600 VAN \* HARRISON UNIT \*

MODEL YEAR	ENGINE SIZE	A.I. PUMP	STEERING	EVAPORATOR KIT	COMPRESSOR	ENGINE KIT	TOTAL PRICE	NOTES
2008-03	V-8	W/VO	PWR	SMCH982	UNIT PACKED		\$2,070.00	3
2008-03	V-6	W/VO	PWR	SMCH975	UNIT PACKED		\$1,512.00	3
2002-96	ALL	W/VO	STD/PWR	SMCH975	UNIT PACKED		\$1,512.00	1,2

1) 124A ALTERNATOR REQUIRES DAYCO 960K6 BELT, 11-0054 \$17.00

2) SOME 2002-99 4.3L ENGINES REQUIRE COMPUTER PROM CHANGE FOR PROPER IDLE - DEALER ITEM ONLY

3) 2006 AND UP MAY NEED SLIGHT HOSE MODIFICATION AND HAVE COMPUTER FLASHED AT GM DEALER

## GMT -600 VAN AFTERMARKET

MODEL YEAR	ENGINE SIZE	A.I. PUMP	STEERING	EVAPORATOR KIT	COMPRESSOR	ENGINE KIT	TOTAL PRICE	NOTES
2002-97	ALL	W/VO	STD/PWR	AR0508523	AR0571603		\$1,001.00	1

1) WITH HARRISON COMPRESSOR 2002-97 4.3/5.0/5.7L W/ 100AMP ALST ORDER DAYCO 96" BELT 5060960

2002-97 4.3/5.0/5.7L W/ 124AMP ALT ORDER DAYCO 97" BELT 5060970

2002-97 6.5L DIESEL AND 2001 6.6L DIESEL W/ OEM VAC PUMP W/ 100AMP ALT ORDER DAYCO BELT 5061020

2002-97 6.5L DIESEL AND 2001 6.6L DIESEL W/ OEM VAC PUMP W/ 130AMP ALT ORDER DAYCO BELT 5061031

# GENERAL MOTORS

## KODIAK / TOPKICK / C-4500 - C-8500 / 40, 50, 60 SERIES

MODEL YEAR	ENGINE SIZE	A.I. PUMP	STEERING	EVAPORATOR KIT	COMPRESSOR	ENGINE KIT	TOTAL PRICE	NOTES
2008-03	6.6L	WO	PWR	BM97GM040-1-2	UC55121	C-4332	\$1,552.00	7
2008-03	8.1L	WO	PWR	BM97GM040-1-2	UC55121	P-5410	\$1,609.00	
2008-03	3126 CAT	WO	PWR	BM97GM040-1-2	UC55121	C-5252	\$1,672.00	8
2002-01	8.1L	WO	PWR	BM97GM021-1-2	UC55121	P-5410	\$1,209.00	
2002-99	7.4L	WO	PWR	BM97GM021-1-2	UC55021	C-4300	\$1,277.00	
2002-98	3126 CAT	WO	PWR	BM97GM021-1-2	UC55121	P-5290 / C-5155	\$1,267.00	3,9
1998-93	3116 CAT	WO	PWR	BM97GM021-1-2	UC55121	P-2911 / C-5123	\$1,217.00	2,4,9
1998-93	6.0L 7.0L GAS	WO	PWR	BM97GM021-1-2	UC55121	P-3890 / C-5139	\$1,222.00	2
1992-90	3116 CAT	WO	PWR	AM14377HD-K		AM5123-K	\$1,504.00	1,5
1992-91	6.0L 7.0L	WO	PWR	AM14377HD-K		AM4232-K	\$1,502.00	1,5,6
1990	366 427	WO	PWR	AM14377HD-K		AM4223-K	\$1,497.00	1,5
1989-81	8.2L GMC	WO	PWR	AM14370D-K		AM44008	\$1,416.00	1
1987-81	3208 CAT	WO	PWR	AM13370D-K		AM44012	\$1,416.00	1
1980-73				AM14374D-K		VARIOUS - CALL		

- 1) INCLUDES LOUVER KIT
- 2) IF TRUCK HAS NO LOUVERS CALL FOR INFORMATION
- 3) USE P-5290/C-5155 FOR 7 GROOVE BELT OR P-5300/C-5151 FOR 8 GROOVE
- 4) ORDER MOUNT # P-5050 IN PLACE OF P-2911 ON '99-'94 VEHICLES ADD \$50
- 5) UNDERDASH SYSTEM FOR VEHICLE NOT EQUIPPED WITH VENTS
- 6) WITH SERPENTINE BELT
- 7) MUST KNOW W OR W/O DUAL ALTERNATORS
- 8) 2003 USE P-5300/C5151 MOUNT
- 9) FOR DIESEL ENGINES, ORDER VACCUUM PUMP BM9100075 \$300.00

## CHEVROLET / GMC W4 ISUZU NPR NRR

MODEL YEAR	ENGINE SIZE	A.I. PUMP	STEERING	EVAPORATOR KIT	COMPRESSOR	ENGINE KIT	TOTAL PRICE	NOTES
2006-98	4.8L, 5.2L	WO	STD/PWR	98GM461-1 98GM461-9	UC55021	C-4314	\$1,460.00	1
2006-95	3.9L	WO	PWR	98GM461-1 98GM461-9	UC55030	P-2600	\$1,425.00	1
2001-96	5.7L	WO	PWR	98GM461-1 98GM461-5	UC55121	P-3770	\$1,230.00	3
1995	5.7L	W/WO	STD/PWR	98GM425-1 98GM425-5	UC55121	P-3770	\$1,230.00	3
1995-92	3.9L	WO	PWR	98GM425-1 98GM425-8	UC55030	P-2600	\$1,445.00	1,2
1995-92	5.7L V8	W/WO	STD/PWR	98GM425-1 98GM425-5	UC55121	P-3770	\$1,283.00	2,3

- 1) COMES WITH REMOTE CONDENSER
- 2) 85-93 NRR AND W5 NEED WIRING HARNES FA910065 ADD \$48
- 3) COMPRESSOR UC55121 SHOULD BE USED IN HD APPLICATIONS
- 4) SF70-6401 CONDENSER REQUIRED. PLEASE ORDER

# GENERAL MOTORS

## GENERAL MOTORS W6/W7 / T6500-T8500/ ISUZU FRR FSR FTR FVR

MODEL YEAR	ENGINE SIZE	A.I. PUMP	STEERING	EVAPORATOR KIT	COMPRESSOR	ENGINE KIT	TOTAL PRICE	NOTES
2002-99	7.8L DIESEL	WO	PWR	98GM465-1 98GM465-5	UC55030	C-4323	\$1,480.00	1
2002-97	6.0L, 7.0L 7.4L	WO	PWR	98GM465-1 98GM465-5	UC55021	C-4300	\$1,559.00	2
2002-97	3116/3126 CAT	WO	PWR	98GM465-1 98GM465-6	UC55122	P-4490 C-4311	\$1,593.00	3
1996-94	7.1L TURBO DIESEL	WO	PWR	98GM427-1 98GM427-6	UC55021	P-4500 C4271	\$1,416.00	1
1994-88	6.5L TURBO	WO	PWR	98GM427-1 98GM427-6	UC55021	C-4174	\$1,419.00	1
1994-88	5.8L W/O C/S PULLEY	WO	PWR	98GM427-1 98GM427-6	UC55021	C-4172	\$1,501.00	1
1989-86	8.4 TURBO DIESEL	WO	PWR	98GM427-1 98GM427-6	UC55021	C-4171	\$1,401.00	1

1) PLEASE INDICATE TURBO OR NON TURBO

2) GAS ENGINES

3) PLEASE INDICATE NUMBER OF GROOVES ON CRANK DRIVE PULLEY

# BUICK AND OLDSMOBILE

## SOMERSET, SKYLARK, ACHIEVA, CALAIS

MODEL YEAR	ENGINE SIZE	A.I. PUMP	STEERING	EVAPORATOR KIT	COMPRESSOR	ENGINE KIT	TOTAL PRICE	NOTES
1996-92	2.3,2.4,2.5L	SEE GRAND AM						

# PONTIAC

## GRAND AM

MODEL YEAR	ENGINE SIZE	A.I. PUMP	STEERING	EVAPORATOR KIT	COMPRESSOR	ENGINE KIT	TOTAL PRICE	NOTES
1996	2.4L	WO	PWR	SFGM-53934	UC55121	P-4050	\$834.00	1
1995-92	2.3L QUAD 4	WO	PWR	SFGM-53934	UC54120	C-4293	\$909.00	

1) WIRING CHANGES NECESSARY

## SOLSTICE

MODEL YEAR	ENGINE SIZE	A.I. PUMP	STEERING	EVAPORATOR KIT	COMPRESSOR	ENGINE KIT	TOTAL PRICE	NOTES
2008-06	2.4L	WO	PWR	BM97GM030-1-2	14-0441NC	C-4337	\$2,299.00	1
2008-07	2.0L	WO	PWR	BM97GM028-1-2	14-0441NC	C-4337	\$2,299.00	1

1) KIT HAS OEM ALUMINUM CONDENSER, COMPRESSOR &amp; RECEIVER DRIER, BCM NEEDS TO BE FLASHED AFTER INSTALL

# SATURN

## SATURN

MODEL YEAR	ENGINE SIZE	A.I. PUMP	STEERING	EVAPORATOR KIT	COMPRESSOR	ENGINE KIT	TOTAL PRICE	NOTES
ALL	NO KITS AVAILABLE AT THIS TIME							

# INTERNATIONAL - NAVISTAR

## PICKUP

MODEL YEAR	ENGINE SIZE	A.I. PUMP	STEERING	EVAPORATOR KIT	COMPRESSOR	ENGINE KIT	TOTAL PRICE	NOTES
1980-76	V-8	W/WO	STD/PWR		AM15402-11001		\$1,410.00	
1975-72	V-8	W/WO	STD/PWR		AM13281-11001		\$1,447.00	

## SCOUT

MODEL YEAR	ENGINE SIZE	A.I. PUMP	STEERING	EVAPORATOR KIT	COMPRESSOR	ENGINE KIT	TOTAL PRICE	NOTES
1980-72	V-8, 4 CYL	W/WO	STD/PWR		AM15402-11001		\$1,440.00	

## 4900 SERIES

MODEL YEAR	ENGINE SIZE	A.I. PUMP	STEERING	EVAPORATOR KIT	COMPRESSOR	ENGINE KIT	TOTAL PRICE	NOTES
2002	DT466	W/WO	STD/PWR		AM15410-55080		\$1,900.00	

## 4000 - 7000 SERIES WITH DASH LOUVERS

MODEL YEAR	ENGINE SIZE	A.I. PUMP	STEERING	EVAPORATOR KIT	COMPRESSOR	ENGINE KIT	TOTAL PRICE	NOTES
2002	4900 W/ DT466	WO	PWR	AM15410-55080	UNIT PACKED		\$1,900.00	1
1998-96	6.6L - 7.6L	WO	PWR	SMIH-480	UC55021	P-4680 / C-5140	\$1,481.00	1
1998-96	T444E 7.3L	WO	PWR	SMIH-480	UC55121	C-5141	\$1,322.00	1,2
1998-96	T444E 7.3L W/AIR BRAKES	WO	PWR	SMIH-480	UC55121	C-5142	\$1,339.00	1,2

1) MUST KNOW IF SMALL CHARGE OR LARGE CHARGE RADIATOR

2) MUST HAVE HD ALT WITH OE COMPRESSOR BRACKET

## 4000 - 7000 SERIES WITHOUT DASH LOUVERS

MODEL YEAR	ENGINE SIZE	A.I. PUMP	STEERING	EVAPORATOR KIT	COMPRESSOR	ENGINE KIT	TOTAL PRICE	NOTES
1995-94	DT408-466	WO	STD/PWR	AM15407-K	AM-5140-K		\$1,583.00	1
1993-88	DT408-466	WO	STD/PWR	AM15407-K	AM-5079-K		\$1,583.00	1
1994-89	7.3L	WO	PWR	AM15407-K	AM-5122-K		\$1,429.00	1
1991-83	6.9L	WO	STD/PWR	AM15407-K	AM-5109-K		\$1,429.00	1
1989-83	6 CYL 10.0L	WO	PWR	AM15407-K	AM-5101-K		\$1,462.00	1,2
1987-79	DT466	WO	STD/PWR	AM15407-K	AM-5105-K		\$1,494.00	1

1) WILL NOT FIT AUTO TRANS WITH DASH SHIFTER WITHOUT MODIFICATION

2) IF 10.0L TRUCK HAS EXTENDED ENGINE COVER UNIT WILL NOT FIT

# STERLING

## STERLING CONVENTIONAL CAB

MODEL YEAR	ENGINE SIZE	A.I. PUMP	STEERING	EVAPORATOR KIT	COMPRESSOR	ENGINE KIT	TOTAL PRICE	NOTES
2000-99	3126 CAT	WO	PWR	AM13500	AM5151-K		\$1,578.00	
2000-99	5.9L CUMMINGS	WO	PWR	AM13500	AM45004980-K		\$1,597.00	
2000-99	8.3L CUMMINGS	WO	PWR	AM13500	AM45003840-K		\$1,785.00	

**SEE FORD LN SERIES FOR OTHER LISTINGS**

# IMPORTS

## ACURA

### INTEGRA

MODEL YEAR	ENGINE SIZE	A.I. PUMP	STEERING	EVAPORATOR KIT	COMPRESSOR	ENGINE KIT	TOTAL PRICE	NOTES
1999-98	ALL	W/WO	STD/PWR	FACTORY UNIT - CALL			\$1,265.00	1
1989-87	ALL	W/WO	STD/ PWR	BM97AC001	UC55321	C-9111	\$1,279.00	

1) LIMITED SUPPLY - CALL FOR AVAILABILITY

## DAEWOO

### LANOS

MODEL YEAR	ENGINE SIZE	A.I. PUMP	STEERING	EVAPORATOR KIT	COMPRESSOR	ENGINE KIT	TOTAL PRICE	NOTES
2000	1.6L	WO	STD	FACTORY UNIT			\$775.00	3
1999	1.6L	WO	STD	98DW401	UC55021	P-5110	\$685.00	1,2

1) CAR NEEDS TO BE EQUIPPED WITH FACTORY H.D. RADIATOR FOR WARMER CLIMATES

2) ORDER FA910127 \$68.00 FOR FACTORY SWITCHING OR FA910129 \$40.00 FOR AFTERMARKET

3) 98DW401 WILL FIT THE 2000 WITH SWITCH FA910128 \$40.00

## HONDA

### ACCORD

MODEL YEAR	ENGINE SIZE	A.I. PUMP	STEERING	EVAPORATOR KIT	COMPRESSOR	ENGINE KIT	TOTAL PRICE	NOTES
2002-98	2.2L, 2.3L	WO	PWR	CM2102*	UC55121	C-9070	\$1,266.00	1
1997-94	2.2L	WO	PWR	CM2048*	UC55121	C-9070	\$1,450.00	1
1993-90	2.2L	WO	PWR	CM2001*	UC55121	C-9070	\$964.00	1,2
1989-86	2.0L	WO	PWR	AM16770-9060	UNIT PACK		\$1,400.00	
1985-84	1.9L	WO	STD/PWR	AM16750-K	AM9061-K		\$1,253.00	

1) LIMITED AVAILABILITY CALL FIRST

2) WHEN SUPPLY EXHAUSTED ORDER AM16775-9070

### CIVIC / DEL SOL / CRX

MODEL YEAR	ENGINE SIZE	A.I. PUMP	STEERING	EVAPORATOR KIT	COMPRESSOR	ENGINE KIT	TOTAL PRICE	NOTES
2012	ALL	WO	STD/PWR	CIVIC2012	UNIT PACK		\$2,236.00	
2011-07	COUPE	WO	STD/PWR	CIVIC2007-COUPE	UNIT PACK		\$1,920.00	
2003-01	ALL	WO	STD/PWR	CIVIC2003	UNIT PACK		\$1,752.00	1,2,5,6 7
2000-99	1.6L	WO	STD/PWR	BM97HA005-1-2	UC52080	C-9159	\$1,017.70	1,2,5,6 7
1998-96	1.6L	WO	STD/PWR	BM97HA004-1-2	UC52080	C-9159	\$1,115.70	
1995-92	1.5L	WO	STD/PWR	BM97HA003-1-2	UC52080	C-9111	\$1,140.80	1,2,3,6 8
1991-88	1.5L 1.6L	WO	STD/PWR	AM16765-003870	UNIT PACK		\$1,448.00	4
1987-84	1.3L & 1.5L	WO	STD/PWR	AM16760-9039	UNIT PACK		\$1,350.00	

1) DOES NOT FIT "V-TEC" ENGINE WITHOUT MODIFICATION

2) FOR DEL SOL ORDER SWITCH COVER H396269 \$15.00

3) CAN USE UC52314 WITH P-3980

4) CAN USE UC52314 WITH P-3871

5) CAN USE UC55141 WITH P-4370

6) CAN USE SFHD-CM2019-00 EXTRA COST CALL

7) CAN USE CM2019 WITH CM4402047-50 EXTRA COST CALL

8) CAN USE CM2019 WITH CM4402019-50 EXTRA COST CALL

### ELEMENT

MODEL YEAR	ENGINE SIZE	A.I. PUMP	STEERING	EVAPORATOR KIT	COMPRESSOR	ENGINE KIT	TOTAL PRICE	NOTES
2004-03				ELEMENT	UNIT PACK		\$1,750.00	1

1) FACTORY UNIT

# IMPORTS

## HONDA - CONTINUED

### PRELUDE

MODEL YEAR	ENGINE SIZE	A.I. PUMP	STEERING	EVAPORATOR KIT	COMPRESSOR	ENGINE KIT	TOTAL PRICE	NOTES
1995-91	<b>DEALER ONLY</b>							
1990-88	2.0L	WO	PWR	AM16748	AM993780K		\$1,274.00	1
1987-83	1.8L 1.9L	WO	STD/PWR	AM16745-K	AM9061-K		\$1,267.00	

1) 2.0L ENGINE ONLY, DOES NOT FIT 2.3L

### PASSPORT

MODEL YEAR	ENGINE SIZE	A.I. PUMP	STEERING	EVAPORATOR KIT	COMPRESSOR	ENGINE KIT	TOTAL PRICE	NOTES
1997-96	3.2L	WO	STD/PWR	SFGM-44334	UC54334	P-3130	\$884.00	2,3,4
1997-94	2.6L	W/WO	STD/PWR	SFGM-44334	UC55021	P-1370	\$908.00	1, 2, 4
1995-94	3.2L	WO	STD/PWR	SFGM-44334	UC55141	P-3130	\$884.00	2,4

1) 70-3562 IDLE UP OPTION \$46.00

2) ORDER 13-0766 FOR 95.5 - 97 \$13.50

3) FOR BETTER CLEARANCE ORDER W05-2077 \$55 SOME HOSE MODIFICATION REQUIRED

4) WHEN SUPPLY EXHAUSTED USE BM OR CM2015

## HYUNDAI

### ACCENT

MODEL YEAR	ENGINE SIZE	A.I. PUMP	STEERING	EVAPORATOR KIT	COMPRESSOR	ENGINE KIT	TOTAL PRICE	NOTES
2012-10	<b>CALL</b>							
2009	1.6L DOHC	WO	STD/PWR	BM97HY005	UNIT PACKED		\$2,301.00	
2008	1.6L DOHC	WO	STD/PWR	BM97HY004	UNIT PACKED		\$2,301.00	
2006	1.6L DOHC	WO	STD/PWR	BM97HY003	UNIT PACKED		\$2,465.00	1,3
2005-01	1.6L DOHC	WO	STD/PWR	BM97HY002-1-2	14-DK55141NC	P-5610	\$962.00	2,3
2004-00	1.5L	WO	STD/PWR	BM97HY002-1-2	14-DK55141NC	C-3087		
1999-95	1.5L	W/WO	STD/PWR	BM97HY001-1-2	14-DK55122NC	P-4141 / C-3087	\$999.00	

1) DOES NOT WORK ON 1.6L ENGINE

2) SOME FACTORY UNITS AVAILABLE PLEASE CALL. PART # ACCENT1.6 \$950

3) NEED TO KNOW ENGINE SIZE AND RADIATOR LENGTH, ADD BM9100100 \$63 AND BM9100009 \$52

### EXCEL

MODEL YEAR	ENGINE SIZE	A.I. PUMP	STEERING	EVAPORATOR KIT	COMPRESSOR	ENGINE KIT	TOTAL PRICE	NOTES
1994-92	1.5L	WO	STD/PWR	SF30-0172	UC55021	C-3067	\$931.00	1
1991-90	1.5L	WO	STD/PWR	SF30-0172	UC55021	C-3067	\$931.00	

1) ORDER SWITCH 13-0580 INCLUDED IN PRICE

### ELANTRA

MODEL YEAR	ENGINE SIZE	A.I. PUMP	STEERING	EVAPORATOR KIT	COMPRESSOR	ENGINE KIT	TOTAL PRICE	NOTES
2009-08	ALL	WO	STD/PWR	ELANTRA2008	FACTORY UNIT PACK		\$1,300.00	
2000-96	1.8L	WO	STD/PWR	ELANTRA	FACTORY UNIT PACK		\$890.00	

### SCOPE

MODEL YEAR	ENGINE SIZE	A.I. PUMP	STEERING	EVAPORATOR KIT	COMPRESSOR	ENGINE KIT	TOTAL PRICE	NOTES
1992-91	1.5L	WO	STD/PWR	30-0172	UC55021	C-3067	\$931.00	1,2

1) MUST FIND OUT IF CRANK SHAFT PULLEY IS ON DRIVER OR PASSENGER SIDE

2) REQUIRES SWITCH FROM DEALER

# IMPORTS

## ISUZU

### HOMBRE

MODEL YEAR	ENGINE SIZE	A.I. PUMP	STEERING	EVAPORATOR KIT	COMPRESSOR	ENGINE KIT	TOTAL PRICE	NOTES
2000-96	SEE S-10 IN GENERAL MOTORS SECTION							

### PICKUP / AMIGO / RODEO

MODEL YEAR	ENGINE SIZE	A.I. PUMP	STEERING	EVAPORATOR KIT	COMPRESSOR	ENGINE KIT	TOTAL PRICE	NOTES
2002-98	2.2L	W/WO	STD/PWR	CM2071	UC55121	C-9161	\$877.00	5
2002-98	3.2L	W/WO	STD/PWR	CM2071	UC55121	P-4550 / C-9160	\$842.00	5,7
1997-88.5	2.3L 2.6L	W/WO	STD/PWR	SFGM-44334	UC55021	P-1370 / C-4131	\$888.00	1,2,5,9,10
1997-93	3.2L	W/WO	STD/PWR	SFGM-44334	UC54334	P-3130	\$894.00	4,5,8,9,10,11
1993-89	3.1L	W/WO	STD/PWR	SFGM-44334	UC55021	P-2090	\$989.00	9,10
1988-87	2.3L	W	STD/PWR	BM97IS001-1-2	UC55021	P-1370 / C-4131	\$1,101.00	3,6,9,10

- 1) ORDER 2.3L IDLE UP 85-1800 \$66.00, 2.6L OR 2.3L W/ EFI IDLE UP SF70-3562 \$46.00 NOT INCLUDED IN TOTAL PRICE  
 2) WITH 2.3L ORDER SHROUD & FAN KIT 13-0834 \$67.00  
 3) ORDER 2.3L FAN SHROUD FROM DEALER IF NOT EQUIPPED  
 4) FOR '95.5-'96 VEHICLES ORDER 13-0766 \$13.50  
 5) DOES NOT FIT '96-'99 PICKUP - SEE HOMBRE SECTION  
 6) HD BLOWER MOTOR ORDER SF70-3058 \$51.00  
 7) HIGHLY SUGGEST USING FACTORY KIT ON 3.2L RODEO LOUD COMPRESSOR NOISE USUALLY  
 8) ORDER MANIFOLD W05-2077 (ADD \$55) FOR CLEARANCE, HOSE MODIFICATION NEEDED  
 9) WHEN SUPPLY EXHAUSTED USE CM2015 OR BM97IS001-1-2. PLEASE CHECK FOR APPROPRIATE KITS FOR EACH BASIC.  
 10) 2.3L AND 2.6L REQUIRE HOSE KIT SF70-4518 ADD \$100 CALL FOR 3.1 OR 3.2 HOSE KIT  
 11) IF 4X4 USE MOUNT C-4272 EXTRA COST

### NPR NRR

MODEL YEAR	ENGINE SIZE	A.I. PUMP	STEERING	EVAPORATOR KIT	COMPRESSOR	ENGINE KIT	TOTAL PRICE	NOTES
PLEASE SEE W4/W5 IN GENERAL MOTORS SECTION								

### TROOPER II

MODEL YEAR	ENGINE SIZE	A.I. PUMP	STEERING	EVAPORATOR KIT	COMPRESSOR	ENGINE KIT	TOTAL PRICE	NOTES
2005-92	3.2L 3.5L	W/WO	STD/PWR	98IS411-1 98IS411-5	UC55121	P-3130 / C-4256	\$1,401.00	1

- 1) USE MOUNT C4272 IF 4X4 P-3130 WILL NOT WORK

## KIA

### RIO

MODEL YEAR	ENGINE SIZE	A.I. PUMP	STEERING	EVAPORATOR KIT	COMPRESSOR	ENGINE KIT	TOTAL PRICE	NOTES
2011-10	1.6	WO	STD	BM97KA013-1-2	UC55121	C-1040	\$2,240.00	1
2009	1.6	WO	STD	BM97KA012-1-2	UC55121	C-1040	\$1,901.00	1
2008-06	1.5L	WO	PWR	BM97KA010-1-2	UC55121	C-1040	\$2,320.00	2
2005-02.5	1.5L, 1.6L	WO	STD	BM97KA006-1-2	UC55121	P-1110	\$1,845.00	1
2005-02.5	1.5L, 1.6L	WO	PWR	BM97KA006-1-2	UC55121	C-1030	\$1,830.00	1
2002-00	1.5L	WO	STD	BM97KA005-1-2	UC55121	P-1110	\$1,845.00	

- 1) GET PRODUCTION DATE  
 2) FACTORY CONTROL HEAD, SENSORS AND EVAPORATOR, SELL FAN RELAY KIT BM9100103 \$30

# IMPORTS

## KIA - CONTINUED

### RONDO

MODEL YEAR	ENGINE SIZE	A.I. PUMP	STEERING	EVAPORATOR KIT	COMPRESSOR	ENGINE KIT	TOTAL PRICE	NOTES
2008-07	2.0L, 2.4L	WO	PWR	BM97KA011-1-2	UC45141	C-1041	\$1,965.00	

### SEPHIA

MODEL YEAR	ENGINE SIZE	A.I. PUMP	STEERING	EVAPORATOR KIT	COMPRESSOR	ENGINE KIT	TOTAL PRICE	NOTES
2002-98	1.8L	WO	PWR	CM2120	UC55121	P-5140	\$724.00	
2002-98	1.8L	WO	STD	CM2120	UC55121	P-5020	\$735.00	

### SPORTAGE

MODEL YEAR	ENGINE SIZE	A.I. PUMP	STEERING	EVAPORATOR KIT	COMPRESSOR	ENGINE KIT	TOTAL PRICE	NOTES
2009-05	2.0L	WO	PWR	BM97KA009-1-2	UC55122	C-1040	\$2,200.00	
2002-01	2.0L	WO	PWR	BM97KA007-1-2	UC55021	P-4100 / C-1037	\$1,585.00	
2000-98	2.0L	WO	PWR	BM97KA003-1-2	UC55021	P-4100 / C-1037	\$1,210.00	

## MAZDA

### 323 / PROTEGE

MODEL YEAR	ENGINE SIZE	A.I. PUMP	STEERING	EVAPORATOR KIT	COMPRESSOR	ENGINE KIT	TOTAL PRICE	NOTES
1998-95	1.6L 1.8L	WO	STD	CM2035	UC55121	P-1110 / C-7108	\$1,043.00	
1998-95	1.6L 1.8L	WO	PWR	CM2035	UC55121	C-1030	\$1,027.00	
1994-90	1.6L 1.8L	WO	STD	CM2024	UC55121	P-1110 / C-7108	\$1,051.00	
1994-90	1.6L 1.8L	WO	PWR	CM2024	UC55121	C-1030	\$1,035.00	
1989-86	1.6L MAN TRANS	WO	STD	BM97MZ002-1-2	UC55121	P-1110 / C-7108	\$1,560.00	
1989-86	1.6L AUTO TRANS	WO	STD	BM97MZ002-1-2	UC55121	C-7111	\$1,505.00	
1989-86	1.6L	WO	PWR	BM97MZ002-1-2	UC55121	C-1030	\$15,485.00	

### 626

MODEL YEAR	ENGINE SIZE	A.I. PUMP	STEERING	EVAPORATOR KIT	COMPRESSOR	ENGINE KIT	TOTAL PRICE	NOTES
1992-88	2.2L	WO	PWR	AM16645	AM1031-K		\$1,396.00	1, 2, 3
1992-88	2.2L	WO	STD	AM16645	AM1033-K		\$1,354.00	1, 2, 3

- 1) DOES NOT FIT VEHICLES WITH ELECTRONIC CONTROL PANEL
- 2) WHEN EXISTING STOCK IS EXHAUSTED USE 98MZ415 & SWITCH FROM DEALER
- 3) CAN NOT USE 3 EYE COMPRESSOR

### MIATA

MODEL YEAR	ENGINE SIZE	A.I. PUMP	STEERING	EVAPORATOR KIT	COMPRESSOR	ENGINE KIT	TOTAL PRICE	NOTES
1998-94	4CYL	WO	STD	AM16672		AM11027	\$1,445.00	1
1998-94	4CYL	WO	PWR	AM16672		AM11028	\$1,445.00	1
1993-90	4CYL	WO	STD	AM16670		AM11027	\$1,440.00	2
1993-90	4CYL	WO	PWR	AM16670		AM11028	\$1,410.00	2

- 1) KIT FOR CAR EQUIPPED WITH O.E, EVAP FROM FACTORY
- 2) KIT FOR CAR NOT EQUIPPED WITH FACTORY EVAP



# IMPORTS

## MAZDA - CONTINUED

### MAZDA 3

MODEL YEAR	ENGINE SIZE	A.I. PUMP	STEERING	EVAPORATOR KIT	COMPRESSOR	ENGINE KIT	TOTAL PRICE	NOTES
2009-07	4CYL	WO	PWR	BM97MZ013	UNIT PACKED		\$2,360.00	1,2
2006-05	4CYL	WO	PWR	BM97MZ012	UNIT PACKED		\$2,360.00	1,2

1) MUST HAVE PRODUCTION DATE

2) HARD INSTALL LOTS OF LABOR

### MX3

MODEL YEAR	ENGINE SIZE	A.I. PUMP	STEERING	EVAPORATOR KIT	COMPRESSOR	ENGINE KIT	TOTAL PRICE	NOTES
1993-90	1.8L 1.6L	WO	PWR	AM16655-K	AM1030-K		\$1,294.00	
1993-90	1.8L 1.6L	WO	STD	AM16655-K	AM7108-K		\$1,354.00	

### PICKUP

MODEL YEAR	ENGINE SIZE	A.I. PUMP	STEERING	EVAPORATOR KIT	COMPRESSOR	ENGINE KIT	TOTAL PRICE	NOTES
2010-07	2.3L	WO	PWR	BM97FD016R-07	UNIT PACKED		\$1,750.00	O.E. PARTS
2010-07	2.3L	WO	PWR	BM97FD075-1-2 BM9100088 & 89	UC52038	P-5450/C-7156	\$1,865.00	7,10
2010-07	3.0L	WO	PWR	BM97FD077-1-2	UC52038	C-7180	\$1,450.00	4
2010-07	4.0L	WO	PWR	BM97FD078-1-2	UC55122	C-7150	\$1,460.00	4
2006-04	2.3L	WO	PWR	BM97FD037-1-2	UC52038	P-5450/C-7156	\$1,630.00	4
2006-04	3.0L, 4.0L	WO	PWR	BM97FD035-1-2	UC55121	C-7150	\$1,485.00	5
2003-98	3.0L, 4.0L	WO	PWR	BM97FD016-1-2	UC55122	C-7150	\$1,480.00	9
2003-98	2.5L	WO	STD	BM97FD016-1-2	UC55121	C-7156	\$1,575.00	6,7,9
2003-98	2.5L	WO	PWR	BM97FD016-1-2	UC55121	C-7159	\$1,460.00	6,7,9
2003-01	2.3L	WO	PWR	BM97FD030-1-2 BM9100088 & 89	UC45088	C-7174	\$1,620.00	
1997-95	2.3L	WO	PWR	BM97FD011-1-2	UC55121	C-7159	\$1,415.00	1,7,8
1997-95	2.3L	WO	STD	BM97FD011-1-2	UC55121	P-3790 / C-7156	\$1,530.00	1,7,8
1997-95	3.0L	WO	PWR	BM97FD011-1-2	UC55121	C-7171	\$1,440.00	7,8
1997-95	4.0L	WO	PWR	BM97FD011-1-2	UC55122	P-2180 / C-7138	\$1,435.00	7,8
1994	2.3L	WO	PWR	BM97FD007-1-2	UC55121	C-7142	\$1,400.00	1,3
1994	2.3L	WO	STD	BM97FD007-1-2	UC55121	P-2590 / C-7143	\$1,400.00	1,3
1994	3.0L	WO	PWR	BM97FD007-1-2	UC55121	C-7171	\$1,450.00	3
1994	4.0L	WO	PWR	BM97FD007-1-2	UC55122	C-7138	\$1,440.00	3
1994	2.9L	WO	PWR	BM97FD007-1-2	UC55021	C-7089	\$1,520.00	2,3
1993-89	2.6L EFI	WO	STD / PWR	BM97MZ003-1-2	UC55021	C-1034	\$1,530.00	5
1993-87	2.0L, 2.2L	WO	STD	BM97MZ003-1-2	UC55021	C-1023	\$1,520.00	5
1993-87	2.0L, 2.2L	WO	PWR	BM97MZ003-1-2	UC55021	C-1025	\$1,480.00	
1988-87	2.6L	WO	STD / PWR	BM97MZ003-1-2	UC55021	C-3041	\$1,520.00	

1) FAN SHROUD 13-0329 OR CM3800701-17 \$58.00 REQUIRED WHEN NOT EQUIPPED FROM FACTORY - NOT INCLUDED IN TOTAL PRICE

2) 1988-82 REQUIRE FAN SHROUD BM9100052 \$100

3) IN 92-94 SOME MODELS BUILT WITHOUT GREEN WIRE AT OEM 8 PIN CONNECTOR IN KICK PANEL ORDER BM9100058 \$76

4) PLATE FIN EVAP

5) OPTIONAL IDEL UP BM9100034 \$104

6) ORDER FAN SHROUD BM9100065 \$100 IF NOT EQUIPPED

7) 1997.5 NEED WIRING HARNESS BM9100060 \$74

8) USE MODE SWITCH PROVIDED IN KIT

9) 1998-99 IF VEHICLE IS EQUIPPED WITH O.E. WIRING (PRESSURE CYCLING SWITCH PLUG PRESENT) ORDER BM9100064 \$70

10) SELL "RANGER INSTRUCT" FOR 2006 AND UP RANGER UNITS

# IMPORTS

## MAZDA - CONTINUED

### MPV VAN

MODEL YEAR	ENGINE SIZE	A.I. PUMP	STEERING	EVAPORATOR KIT	COMPRESSOR	ENGINE KIT	TOTAL PRICE	NOTES
1992-89	2.6L	W/WO	STD		AM16660-1034		\$1,182.00	
1992-89	3.0L	W/WO	PWR		AM16660-1032		\$1,185.00	

### NAVAJO

MODEL YEAR	ENGINE SIZE	A.I. PUMP	STEERING	EVAPORATOR KIT	COMPRESSOR	ENGINE KIT	TOTAL PRICE	NOTES
1994-91	4.0L	WO	STD/PWR	BM97FD007-1-2	UC55122	C-7138	\$1,440.00	

## MITSUBISHI

### ECLIPSE

MODEL YEAR	ENGINE SIZE	A.I. PUMP	STEERING	EVAPORATOR KIT	COMPRESSOR	ENGINE KIT	TOTAL PRICE	NOTES
1999-95	2.0L NON TURBO	WO	PWR	BM97CH029-1-2	UC55141	C-3085	\$1,510.00	1,2
1994-90	2.0L	WO	STD/PWR	SF30-0022	UC55141	C-3070	\$700.00	
1994-90	1.8L	WO	STD/PWR	SF30-0022	UC42118	C-3083	\$725.00	

### EXPO

MODEL YEAR	ENGINE SIZE	A.I. PUMP	STEERING	EVAPORATOR KIT	COMPRESSOR	ENGINE KIT	TOTAL PRICE	NOTES
1996-92	1.8L	WO	PWR	CM2881	UC55121	P-2830 / C-3078	\$911.00	2
1996-92	2.4L	WO	PWR	CM2881	UC4508	P-3190	\$935.00	1,2

1) SOME HOSE MODIFICATION NEEDED

2) LIMITED AVAILABILITY

### MIRAGE

MODEL YEAR	ENGINE SIZE	A.I. PUMP	STEERING	EVAPORATOR KIT	COMPRESSOR	ENGINE KIT	TOTAL PRICE	NOTES
2002-97	4 CYL 1.5L	WO	STD/PWR	BM97MS001-1-2	UC55121	P-4800	\$1,475.00	2
1999-97	4 CYL 1.8L	WO	PWR	BM97MS001-1-2	UC55121	P-2830 / C-3078	\$1,500.00	2
1996-93	4 CYL 1.5L	WO	STD/PWR	SF30-0030	UC55021	P-2870 / C-3045	\$896.00	3
1992-89	4 CYL 1.5L FWD	WO	STD/PWR	SFCH-12634	UC55021	P-2870 / C-3045	\$880.00	1

1) WILL NOT FIT 1.6L

3) CALL IF 1.8L

2) ORDER 9100090 SWITCH 97-98 \$122 OR 9100091 SWITCH 99-02 \$92

### PRECIS

MODEL YEAR	ENGINE SIZE	A.I. PUMP	STEERING	EVAPORATOR KIT	COMPRESSOR	ENGINE KIT	TOTAL PRICE	NOTES
1994-92	1.5L	WO	STD/PWR	SF30-0172	UC55021	C-3067	\$931.00	1
1991-90	1.5L	WO	STD/PWR	SF30-0172	UC55021	C-3067	\$931.00	

1) ORDER SWITCH 13-0580 \$18.00 INCLUDED IN TOTAL PRICE

# IMPORTS

## MITSUBISHI - CONTINUED

### MONTERO

MODEL YEAR	ENGINE SIZE	A.I. PUMP	STEERING	EVAPORATOR KIT	COMPRESSOR	ENGINE KIT	TOTAL PRICE	NOTES
1991-86	2.6L	WO	PWR	BM97CH006-1-2	UC55021	C-3041	\$1,103.49	
1991-86	3.0L	WO	PWR	BM97CH006-1-2	UC55021	C-7032	\$1,146.00	

### FUSO TRUCK

MODEL YEAR	ENGINE SIZE	A.I. PUMP	STEERING	EVAPORATOR KIT	COMPRESSOR	ENGINE KIT	TOTAL PRICE	NOTES
2000-96	6 CYL	WO	PWR	98MI403	UC55021	95MI002	\$1,663.00	1,2
2000-96	4 CYL	WO	PWR	98MI403	UC55021	95MI003	\$1,663.00	1,2
1995-92	4 CYL 3.9L	WO	PWR	98MI402	UC55021	95MI004	\$1,663.00	1,2
1991	4 CYL 3.5L	WO	STD/PWR	98MI402	UC55021	95MI001	\$1,663.00	1,2

1) DOES NOT WORK ON MANUAL TRANSMISSION VEHICLES

2) ONE LEFT AT TIME OF PRINTING-CALL

### PICKUP

MODEL YEAR	ENGINE SIZE	A.I. PUMP	STEERING	EVAPORATOR KIT	COMPRESSOR	ENGINE KIT	TOTAL PRICE	NOTES
1996-87	4 CYL 2000/2400CC	WO	STD/PWR	BM97CH008-1-2	UC55021	P-1510 / C-3051	\$1,510.00	1, 2, 3
1991-90	V-6 3.0L 2WD ONLY	WO	STD/PWR	BM97CH008-1-2	UC55021	P-2110 / C-3072	\$1,530.00	
1989-87	4 CYL 2600CC	WO	STD/PWR	BM97CH008-1-2	UC55021	P-1520 / C-3041	\$1,500.00	4
1986-83	2.0L	WO	STD/PWR	98CH404-1 98CH404-5	UC55021	P-1510 / C-3051	\$1,045.00	5
1986-83	2.6L	WO	STD/PWR	98CH404-1 98CH404-5	UC55021	P-1520 / C-3041	\$1,012.00	5

1) ORDER FAN SHROUD FROM DEALER

2) 14-0734 SHROUD PACKAGE FOR VEHICLES WITH AUTOMATIC TRANSMISSION \$50.00 NOT INCLUDED IN PRICE

3) 14-0735 SHROUD PACKAGE FOR VEHICLES WITH 4 WHEEL DRIVE \$50.00 NOT INCLUDED IN PRICE

4) ORDER FAN SHROUD FROM DEALER

5) PURCHASE FAN SHROUD FROM DEALER IF NOT EQUIPED

## NISSAN

### ALTIMA

MODEL YEAR	ENGINE SIZE	A.I. PUMP	STEERING	EVAPORATOR KIT	COMPRESSOR	ENGINE KIT	TOTAL PRICE	NOTES
2004-02	2.5L	WO	PWR	BM97NN015-1-2	UC55121	C-6097	\$2,420.00	1,2
2001-00	2.4L	WO	PWR	BM97NN018-1-2	UC55121	C-6098	\$1,865.00	1,2
1999-98	2.4L	WO	PWR	BM97NN017-1-2	UC55121	C-6098	\$1,865.00	1,2

1) SPECIAL ORDER

2) NEED TO KNOW 4-DIGIT COLOR CODE# -FOUND IN DOOR JAM OR FIRE WALL

### 200SX

MODEL YEAR	ENGINE SIZE	A.I. PUMP	STEERING	EVAPORATOR KIT	COMPRESSOR	ENGINE KIT	TOTAL PRICE	NOTES
2000-95	1.6L	WO	STD/PWR	BM97NN010-1-2	UC55121	P-4030 / C-6091	\$1,780.00	1

1) SPECIAL ORDER

# IMPORTS

## NISSAN - CONTINUED

### SENTRA

MODEL YEAR	ENGINE SIZE	A.I. PUMP	STEERING	EVAPORATOR KIT	COMPRESSOR	ENGINE KIT	TOTAL PRICE	NOTES
2006-- 5/03	1.8L	WO	STD/PWR	BM97NN020-1-2 BM9100079	UC55121	P-5330	\$2,194.00	2,4
APR 03 - JULY 02	1.8L	WO	STD/PWR	BM97NN019-1-2	UC55121	P-5330	\$1,922.00	2,4
AUG 2002 - 2000	1.8L	WO	STD/PWR	BM97NN014-1-2	UC55121	P-5330	\$1,700.00	2,4
1999-95	1.6L	WO	STD/PWR	BM97NN010-1-2	UC55121	P-4030 / C-6091	\$1,358.00	2,3,4
1994-93	1.6L	WO	STD/PWR	SF30-0048	UC55121	P-3180 / C-6089	\$845.00	1,2
1992-91	1.6L	WO	STD/PWR	SF30-0048	UC55121	P-2730 / C-6086	\$900.00	2
1992-91	2.0L	WO	STD/PWR	SF30-0048	UC55121	C-6088	\$895.00	2
1990-89	1.6L W/SERP ALT BELT	WO	STD/PWR	BM97NN005-1-2	UC55121	P-1540 / C-6082	\$1,131.00	2
1988-87	1.6L W V- BELT ALT	WO	STD/PWR	BM97NN005-1-2	UC55021	C-6079	\$1,180.00	2

1) MANUFACTURED AFTER AUGUST 1992

3) USE BM97NN014 FOR 2000 MODEL

2) NEED PRODUCTION DATE

4) SPECIAL ORDER

### FRONTIER

MODEL YEAR	ENGINE SIZE	A.I. PUMP	STEERING	EVAPORATOR KIT	COMPRESSOR	ENGINE KIT	TOTAL PRICE	NOTES
2012-05	2.5L	WO	PWR	BM97NN021-1-2	14-DK55121NC	C-6099	\$2,585.00	1,3,5
2004-03	3.3L	WO	PWR	BM97NN016-1-3	UC55122	P-5460	\$1,369.56	1,3,6
2004-03	2.4L	W	PWR	BM97NN016-1-2	UC55021	C-6084	\$1,466.00	1,3
2002-01	3.3L	WO	PWR	BM97NN013-1-3	UC55122	P-5460	\$1,063.00	3
2002-01	2.4L	WO	PWR	BM97NN013-1-2	UC55021	C-6084	\$1,416.00	3
2000	4 CYL 2.4L	WO	PWR	BM97NN012-1-2	UC55021	C-6084	\$1,825.00	1,3,4
2000	6 CYL 3.3L	WO	PWR	BM97NN012-1-3	UC52114	C-6095	\$1,765.00	1,3,4
1999-98	4 CYL 2.4L	WO	PWR	CM2073	UC55021	C-6084	\$956.00	2
1999-98	6 CYL 3.3L	WO	PWR	CM2073	UC52114	C-6095	\$936.00	2

1) NEED TO KNOW EXACT PRODUCTION DATE

2) KIT FITS 2000 WITH LEVER TYPE RECIRCULATION DOOR

3) SPECIAL ORDER

4) IF CABLE OPERATED FRESH AIR DOOR USE KIT CM2073

5) FAN KIT BM9100099 \$218

# IMPORTS

## NISSAN - CONTINUED

### PATHFINDER

MODEL YEAR	ENGINE SIZE	A.I. PUMP	STEERING	EVAPORATOR KIT	COMPRESSOR	ENGINE KIT	TOTAL PRICE	NOTES	
1999-96	3.3L	WO	PWR	AM16582-K		AM6095-K	\$1,250.00		
1995-87	SEE PICKUP SECTION								

### PICKUP

MODEL YEAR	ENGINE SIZE	A.I. PUMP	STEERING	EVAPORATOR KIT	COMPRESSOR	ENGINE KIT	TOTAL PRICE	NOTES
2000-98	SEE FRONTIER							
1997-96	2.4L	WO	STD/PWR	BM97NN007-1-2 BM9100054	UC55021	C-6084	\$1,680.00	2
1997-96	3.0L	WO	STD/PWR	BM97NN007-1-3 BM9100054	UC55021	C-6085	\$1,680.00	2
1995-91	2.4L	WO	STD/PWR	BM97NN007-1-2	UC55021	C-6084	\$1,630.00	2
1995-91	3.0L	WO	STD/PWR	BM97NN007-1-3	UC55021	C-6085	\$1,630.00	2
1990-86.5	2.4L	WO	STD/PWR	BM97NN007-1-2	UC55021	C-6047	\$1,600.00	
1990-86.5	3.0L	WO	STD/PWR	BM97NN007-1-3	UC55021	P-0770 / C-6075	\$1,620.00	1
1986-81	2.4L	WO	STD/PWR	BM97NN004-1-2	UC55021	C-6084	\$1,620.00	

1) ON 90 MODEL WITH ELEC MULTIPORT FI ORDER P-3040 / C-6085

2) DOES NOT FIT '98-'96 PATHFINDER

### VERSA

MODEL YEAR	ENGINE SIZE	A.I. PUMP	STEERING	EVAPORATOR KIT	COMPRESSOR	ENGINE KIT	TOTAL PRICE	NOTES
2011-07	1.8L	WO	PWR	BM97NN024-1-2	UC55121	C-6101	\$2,087.00	

# IMPORTS

## SUZUKI

### ESTEEM / BALENO

MODEL YEAR	ENGINE SIZE	A.I. PUMP	STEERING	EVAPORATOR KIT	COMPRESSOR	ENGINE KIT	TOTAL PRICE	NOTES
1997-95	1.6L 16 VLV	WO	STD/PWR	CM2038-00	UC52080	P-3990	\$780.00	

### SWIFT

MODEL YEAR	ENGINE SIZE	A.I. PUMP	STEERING	EVAPORATOR KIT	COMPRESSOR	ENGINE KIT	TOTAL PRICE	NOTES
2001-95	1.0L	WO	STD	BM97GM017-1-2	UC52080	C-4275	\$1,695.00	
2001-95	1.3L	WO	STD	BM97GM017-1-2	UC52080	P-5010 / C-4277	\$1,650.00	
2001-95	1.3L	WO	PWR	BM97GM017-1-2	UC52080	P-3661 / C-4278	\$1,680.00	
1994-89	1.3L	WO	STD	BM97GM016-1-2	UC52080	C-4257	\$1,695.00	1,2

1) MUST ORDER SWITCH 13-0565 \$21.00 FOR '89-'91

2) OPTIONAL IDLE KIT '93-'91 BM9100067 \$97

### SIDEKICK / X/90

MODEL YEAR	ENGINE SIZE	A.I. PUMP	STEERING	EVAPORATOR KIT	COMPRESSOR	ENGINE KIT	TOTAL PRICE	NOTES
1998-92	1.6L 16 VLV	WO	PWR	BM97GM009-1-2	UC52080	C-4294	\$1,695.00	1,3
1998-92	1.6L 16 VLV	WO	STD	BM97GM009-1-2	UC52080	P-3361 / C-4296	\$1,580.00	1,3
1998-89	1.6L	WO	PWR	BM97GM009-1-2	UC52080	P-4760 / C-4284	\$1,595.00	1,3
1998-91	1.6L	WO	STD	BM97GM009-1-2	UC52080	C-4285	\$1,610.00	1,3
1990-89	1.6L	WO	STD	BM97GM009-1-2	UC52080	C-9104	\$1,820.00	2

1) HD COOLING MUST BE FACTORY INSTALLED

2) SOME 89'S ARE EQUIPPED WITH '88 ENGINE - NO MOUNT AVAILABLE

3) CONDENSER MOUNTING WILL NEED MODIFICATION TO FIT X/90

### VITARA

MODEL YEAR	ENGINE SIZE	A.I. PUMP	STEERING	EVAPORATOR KIT	COMPRESSOR	ENGINE KIT	TOTAL PRICE	NOTES
2002-99	1.6L	WO	STD/PWR	BM97GM018-1-2	UC52080	C-4319	\$1,625.00	1,2
2002-99	2.0L	WO	STD/PWR	BM97GM018-1-2	UC52038	P-4970 / C-4322	\$1,660.00	1

1) ORDER SWITCH BM9100083 \$60 2) FACTORY UNIT FOR 2002-99 1.6 AVAILABLE "VITARA"

# IMPORTS

## TOYOTA

### COROLLA

MODEL YEAR	ENGINE SIZE	A.I. PUMP	STEERING	EVAPORATOR KIT	COMPRESSOR	ENGINE KIT	TOTAL PRICE	NOTES
2000-98	1.8L	WO	PWR	CM2072	UC52114	P-4530	\$1,032.00	1
1997-93	1.6L 1.8L	WO	STD/PWR	CM2008	UC55121	C-2057	\$755.00	3
1992-88.5	1.6L	WO	STD/PWR	AM14410-2044	UNIT PACKED		\$1,380.00	1
EARLY 88 1987-84	FWD 1.6L	WO	STD/PWR	AM16838-4137	UNIT PACKED		\$1,282.00	2
87-84 RWD	1.5L 1.6L	WO	STD/PWR	AM16836	AM2041-K		\$1,196.00	

1) LIMITED AVAILABILITY CALL FIRST

2) IF '88 1.6L 16 VLV, ORDER AM2044-K

### TERCEL / PASEO

MODEL YEAR	ENGINE SIZE	A.I. PUMP	STEERING	EVAPORATOR KIT	COMPRESSOR	ENGINE KIT	TOTAL PRICE	NOTES
1999-95	1.5L	WO	PWR	BM97TY006-1-2	UC55121	P-3822 / C-2058	\$2,025.00	
1999-95	1.5L	WO	STD	BM97TY006-1-2	UC52110 / UC7312	P-3140 / C-2042	\$2,140.00	
1994-91	1.5L	WO	PWR	BM97TY005-1-2	UC55121	P-3822 / C-2058	\$1,715.00	
1994-91	1.5L	WO	STD	BM97TY005-1-2	UC52110 / UC7312	P-3140 / C-2042	\$1,740.00	

### PICKUP

MODEL YEAR	ENGINE SIZE	A.I. PUMP	STEERING	EVAPORATOR KIT	COMPRESSOR	ENGINE KIT	TOTAL PRICE	NOTES
1995.5-89	3.0L	WO	STD/PWR	BM97TY002-1-3	UC55021	C-2046	\$1,815.00	5
1995-89	2.4L EFI	WO	STD/PWR	BM97TY002-1-2	UC55021	C-2037	\$1,535.00	2, 5
1990-89	2.4L CARB	W	STD/PWR	BM97TY002-1-2	UC55121	C-2043	\$1,505.00	1, 4
1988	3.0L	WO	STD/PWR	BM97TY001-1-3	UC55021	C-2046	\$1,815.00	3
1988-84	2.2L 2.4L	WO	STD/PWR	BM97TY001-1-2	UC55021	C-2037	\$1,910.00	1,2,3
1988-84	2.2L 2.4L	W	STD/PWR	BM97TY001-1-2	UC55021	P-5280 / C-2007	\$1,870.00	1,3
1983-79	2.2L 2.4L	WO	STD/PWR	AM16874-2037K	UNIT PACKED	UNIT PACKED	\$1,685.00	
1983-79	2.2L 2.4L	W	STD/PWR	AM16874-2007	UNIT PACKED	UNIT PACKED	\$1,685.00	

1) OPTIONAL CARB IDLE UP SF70-6367 ADD \$45.00

2) OPTIONAL EFI IDLE UP BM9100019 \$70

3) INCLUDES SWITCH KIT

4) CHECK FOR POLY GROOVE OR V-BELT

5) LATE IN 95 PICKUP CHANGED TO TACOMA

### T-100

MODEL YEAR	ENGINE SIZE	A.I. PUMP	STEERING	EVAPORATOR KIT	COMPRESSOR	ENGINE KIT	TOTAL PRICE	NOTES
2000-95	3.4L 6 CYL	WO	PWR	BM97TY003-1-2	UC55021	C-2061	\$1,790.00	
2000-93	2.7L 4 CYL	WO	STD/PWR	BM97TY003-1-2	UC55121	C-2059	\$1,650.00	2
1996-92	3.0L	WO	STD/PWR	BM97TY003-1-2	UC55021	C-2046	\$1,565.00	1

1) FAST IDLE RECOMMENDED BM9100063 \$80

2) CHECK CRANK SHAFT CENTER HOLE BEFORE TIGHTENING OR THE PULLEY WILL BREAK

# IMPORTS

## TOYOTA - CONTINUED

### TACOMA

MODEL YEAR	ENGINE SIZE	A.I. PUMP	STEERING	EVAPORATOR KIT	COMPRESSOR	ENGINE KIT	TOTAL PRICE	NOTES
2004-01	2.4L, 2.7L	WO	STD/PWR	AM16877-2059	UNIT PACKED		\$1,570.00	1
2000-95	3.4L	WO	STD/PWR	BM97TY004-1-4	UC55121	C-2061	\$1,540.00	
2000-95	2.4L 2.7L	WO	STD/PWR	BM97TY004-1-2	UC55121	C-2059	\$1,710.00	1,2

- 1) STRONGLY SUGGEST USE OF OPTIONAL IDLE UP KIT BM9100063 \$80  
 2) CHECK CRANK SHAFT CENTER HOLE BEFORE TIGHTENING

### 4-RUNNER

MODEL YEAR	ENGINE SIZE	A.I. PUMP	STEERING	EVAPORATOR KIT	COMPRESSOR	ENGINE KIT	TOTAL PRICE	NOTES
1999-96	3.4L	WO	STD/PWR	BM97TY004-1-2	UC55121	C-2061	\$1,545.00	
1999-96	2.4L 2.7L	WO	STD/PWR	BM97TY004-1-2	UC55121	C-2059	\$1,640.00	3
1995-89	3.0L	WO	STD/PWR	CM2075	UC55121	C-2046	\$998.00	
1995-89 EX '89 2 DOOR	2.4L	WO	STD/PWR	CM2075	UC55121	C-2037	\$1,003.00	
1989 2 DOOR	2.4L EFI	WO	STD/PWR	BM97TY002-1-2	UC55021	C-2037	\$1,535.00	1
1988-84	2.4L EFI	WO	STD/PWR	BM97TY001-1-2	UC55021	C-2037	\$1,680.00	1
1988-84	2.2L - 2.4L	W	STD/PWR	BM97TY001-1-2	UC55021	P-5280 / C-2007	\$1,650.00	2

- 1) OPTIONAL IDLE UP EFI ORDER BM9100019 \$70  
 2) OPTIONAL IDLE UP CARB ORDER SF70-6367. ADD \$45  
 3) CHECK CRANK SHAFT CENTER HOLE BEFORE TIGHTENING

## VOLKSWAGEN

### BEETLE

MODEL YEAR	ENGINE SIZE	A.I. PUMP	STEERING	EVAPORATOR KIT	COMPRESSOR	ENGINE KIT	TOTAL PRICE	NOTES
2001-95	1.5L 1.6L	WO	STD	BM97VW006	UC55021	BM45004120	\$1,910.00	
1994-68	1.6L	WO	STD	BM97VW006	UC52310	C-9168	\$1,950.00	1,2

- 1) WILL NOT FIT SUPER BEETLE, CALL FOR INFO ON SUPER BEETLE  
 2) MUST HAVE PADDED DASH

### CABRIOLET

MODEL YEAR	ENGINE SIZE	A.I. PUMP	STEERING	EVAPORATOR KIT	COMPRESSOR	ENGINE KIT	TOTAL PRICE	NOTES
1992-85	1.8L	WO	STD	AM16911	AM99404		\$1,218.00	
1992-85	1.8L	WO	PWR	AM16911	AM99412		\$1,198.00	



# IMPORTS

## VOLKSWAGEN - CONTINUED

### GOLF / JETTA

MODEL YEAR	ENGINE SIZE	A.I. PUMP	STEERING	EVAPORATOR KIT	COMPRESSOR	ENGINE KIT	TOTAL PRICE	NOTES
2001-99	2.0L	WO	STD/PWR	BM97VW015	UC55121	P-5200	\$1,232.00	
1998-97	1.8L-2.0L GAS	WO	STD/PWR	BM97VW011	UC55121	C-9142	\$1,251.00	1,3,5
1996-93	1.8L-2.0L GAS	WO	STD/PWR	BM97VW005	UC55121	C-9142	\$1,240.00	1,3,4,5
1992-86	1.8L GAS	WO	STD/PWR	BM97VW001	UC55021	C-9107	\$1,088.00	2,3,5

- 1) CALL IF VEHICLE ONLY HAS ONE FAN
- 2) M&D P-2120 REQUIRED 2 GROOVE ON OEM WATER PUMP PULLEY IF NOT EQUIPPED ORDER 026121031 FROM VW DEALER
- 3) CALL FOR ALL DIESEL APPLICATIONS
- 4) WHEN SUPPLY IS EXHAUSTED USEBM97VW005-1-2
- 5) CHECK ON AVAILABILITY BEFORE QUOTING

### RABBIT CONVERTABLE

MODEL YEAR	ENGINE SIZE	A.I. PUMP	STEERING	EVAPORATOR KIT	COMPRESSOR	ENGINE KIT	TOTAL PRICE	NOTES
1988-87	1.8L	WO	PWR	AM16911		AM99412	\$1,198.00	1
1984-83	1.8L	WO	STD	AM16911		AM99404	\$1,218.00	1

- 1) ONLY FITS CAR WITH GLOVE BOX ON TOP SECTION OF DASH

# UNIVERSAL

## UNIVERSAL AND SPECIAL APPLICATION

PART NUMBER	APPLICATION	JOBBER PRICE	NOTES
SMH-5	COMPACT HEATER 7.062"H x 7.387"L x 7.325"D	\$225.00	3
SMUD-12	UNIVERSAL UNDERDASH 5 1/2 x 17 x 12 W/ CHROME FACE	\$251.00	
OM27-40001	UNIVERSAL UNDER SEAT COOL W/HOSES, LOUVERS & DUCTS	\$475.00	2
SMTR10	H-D METAL BTS UNIT 8 x 20 x 14	\$515.00	1
OM27-41502	27*12*6" MINIBUS WOODGRAIN 22220 BTU	\$265.00	4

- 1) AVAILABLE WITH 12V OR 24V - CALL
- 2) REMOTE SWITCHING AVAILABLE ADD \$30.00
- 3) LARGER HEATERS AVAILABLE - CALL
- 4) PICTURED AT BOTTOM



**30-0120 UNIVERSAL UNDERSASH**  
**LENGTH 16" HEIGHT 7.8" DEPTH 12"**  
**W/ ROTARY SWITCH & THERMOSTAT**  
**2 DUAL LOUVERS 200CFM 13700 BTU**  
**\$171.00**  
**\$215.00 HEAT/COOL 30-0120HC**

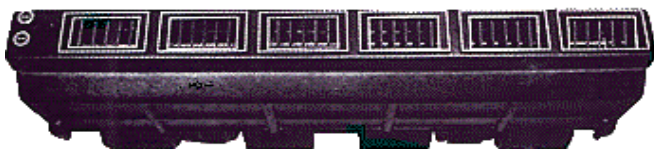

**30-0121 UNIVERSAL OVERHEAD UNIT**  
**LENGTH 35.5" HEIGHT 5" DEPTH 12.5"**  
**HEAVY DUTY STEEL TOP**  
**RATED 30,000 BTU**  
**3 SPEED ROTARY SWITCH**

**\$575.00**

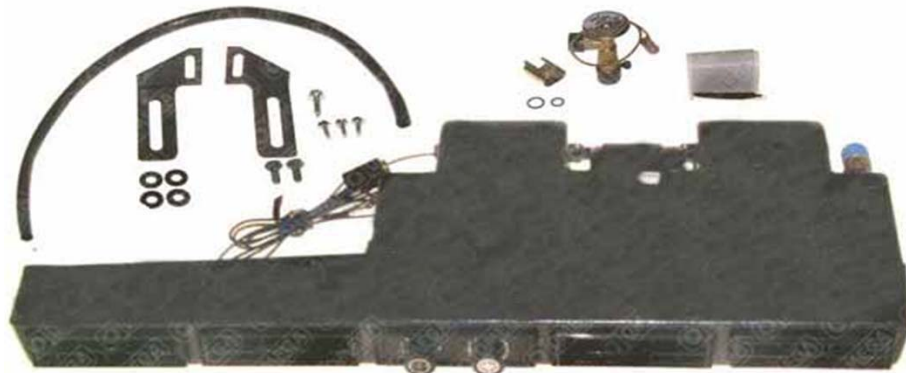

**OM27-40001SL UNIVERSAL**  
**UNDERDASH**  
**25.5"X 9" X 5"**  
**3 SPEED SWITCH AND**  
**THERMOSTAT-CENTER**  
**MOUNTED**

**\$265.00**

**OM27-41502**

**\$265.00**



# UNIVERSAL

## UNIVERSAL AND SPECIAL APPLICATION



**30-0124 4 HOLE 3 SPEED 13700 BTU**  
**16.1 X 15 X 7**  
**\$164.00**  
 REMOTE SWITCHING IS INCLUDED



**30-0131 3 LOUVER REMOTE SWITCH**  
**22,000 BTU 15.75 X 13.5 X 5.75**  
**\$173.00**



**30-0132 GREY UNDERDASH INT SWITCH**  
**13,700 BTU 15.25 X 12.5 X 5**  
**\$171.00**



**30-0133 ROOF MOUNT**  
**REMOTE SWITCH**  
**32,220 BTU**  
**31.75 X 13 X 5.75**  
**\$245.00**



**30-0134 3 LOUVER INT SWITCH**  
**22,000 BTU 15.75 X 13.5 X 5.75**  
**\$173.00**



**30-0135 ROOF MOUNT**  
**6 LOUVER TWIN BLOWER**  
**32,220 BTU**  
**31.75 X 13 X 5.75**  
**\$255.00**  
 REMOTE SWITCHING IS INCLUDED

# VINTAGE AIR



*Hot Rod & Resto  
Award Winning  
Technology!*

**671400-VUZ** - Gen IV Magnum - Heat, Cool & Defrost Model.

**GEN-IV TECHNOLOGY DELIVERS OEM QUALITY CLIMATE CONTROL!**

Enjoy true OEM style bi-level, infinitely adjustable, comfort in your classic car. This Gen IV Magnum system can handle even the largest sedan or wagon.

**671400-VUZ Gen IV Magnum Includes:**  
Evaporator unit, Mounting brackets, Wiring harness, Electric servo heater control valve, Duct hoses, Drain kit.

**Controls** are ordered separately - see next page.

**Under hood components** such as Compressor, Brackets, Condenser, Hose kit, Drier, and Optional upgrades are ordered separately from other sections in this catalog - see index on page 2.

**Gen IV Magnum Features:**

- Fully electronic operation - no cables or vacuum controls
- Micro-processor controlled coil temperature monitor - no capillary tube to install!
- Separate high capacity heat and cool coils
- Aluminum plate /fin A/C coil - most efficient evaporator design available
- Copper/brass Cuprobrazed™ parallel flow heater coil
- In full A/C mode air bypasses heater core resulting in less restriction and increased airflow.
- Servo blend air door for instant temperature adjustment
- Infinite dash/floor air blend
- Infinite defrost/floor air blend with dedicated defrost
- Variable speed blower motor
- Positive shut off solenoid-operated heater control valve in max A/C mode
- Multiple control panel options

Notice the unique shape of the Gen IV Magnum allows fitments in vehicles with higher transmission tunnels and stepped firewalls such as cars of the '50s and later.

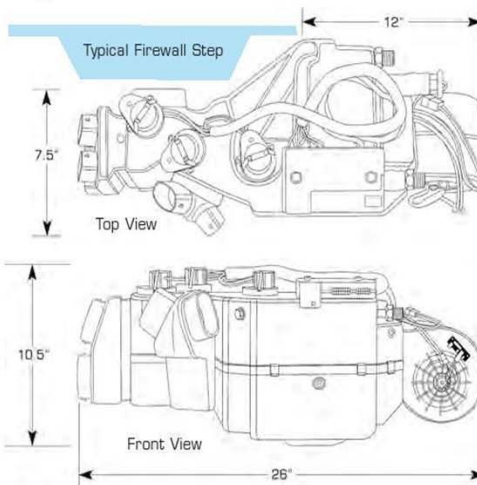

**THE EASIEST WAY TO FIT YOUR EVAPORATOR UNIT INTO PLACE.** These mock-ups are representative cases with jack-nuts and brackets for each system but without the internal components so they are extremely light weight - helpful while holding the unit in place to determine fitment, mounting and hose routing.



**671450** - Gen IV Magnum

# VINTAGE AIR



Vintage Air Manufactures These Vehicle Specific Systems

			Gen IV Electronic System
<b>Chevy</b>	1955-57	Tri-Five Cars	■
	1958-62	Corvette	■
	1963-67	Corvette	■
	1968-76	Corvette	■
	1967-69	Camaro	■
	1970-78	Camaro	■
	1964-65	Chevelle	■
	1966-67	Chevelle/El Camino	■
	1968-72	Chevelle/El Camino	■
	1962-65	Nova	■
	1966-72	Nova	■
	1959-60	Impala	
	1961-64	Impala	■
<b>Pontiac</b>	1964-67	GTO	■
	1967-68	Firebird <small>Same As Camaro System</small>	■
	1969	Firebird	
<b>Mopar</b>	1970-74	Barracuda/Cuda	■
	1970-74	Challenger	■
<b>Ford</b>	1964 ½ -66	Mustang	■
	1967-68	Mustang	■
	1969-70	Mustang	■
	1964-65	Falcon/Ranchero	
<b>Chevy/GMC Trucks</b>	1947-55	Trucks <small>First Series Chevy Truck</small>	
	1947-53	GMC Trucks	
	1956-59	Trucks	
	1960-66	Trucks	
	1967-72	Trucks	■
	1973-86	Trucks	■

# VINTAGE AIR

## LOUVERS - Standard Series



**49052-VUL** 5.25" x 2.5"  
For 2.5" hose.  
**49352-VUL** (all black)



**49055-VUL** 3.625" x 2.375"  
For 2.5" hose.  
**49355-VUL** (all black)



**49057-VUL** 4.75" x 1.562"  
for 2.5" hose.  
**49325-VUL** (all black)



**49327-VUL** 3.875" x 2"  
For 2.5" hose. (all black)



**49193-VUL** Standard Double Vane Louver.  
(All black) Thru-dash mount. 2.875" diameter.  
**49393-VUL** Standard Double Vane Louver.  
(All black) Underdash mount pod.  
2.875" diameter.



**49056-VUL** 3.875" x 1.562" for 2.5" hose.  
**49356-VUL** (all black)  
**49256-VUL** 3.875" x 1.562" for 2" hose.  
**49326-VUL** (all black)



### NEW!

**490535** Double vane louver chrome.  
For 2.5" hose.



**49053-VUL** Thru-dash mount. 2.875" Dia.  
For 2.5" hose.



**49054-VUL** Underdash For 2.5" hose.  
**49354-VUL** Underdash (All black)  
**49154-VUL** Underdash (All chrome)

**49353-VUL** Thru-dash mount (All black)  
**49153-VUL** Thru-dash mount (All chrome)  
**49049-VUL** Thru-dash mount.  
For 3" hose.

**49051-VUL** Left kick panel louver for 2.5" hose.  
**49361-VUL** All black for 2.5" hose.  
**49251-VUL** Left kick panel louver for 3" hose.  
**49151-VUL** Right kick panel louver for 2.5" hose.  
**49351-VUL** All black for 2.5" hose.  
**49252-VUL** Right kick panel louver for 3" hose.



**49066-VUL** 90° Angle flow louvers.  
3.88" x 1.57" w/chrome trim.

**49366-VUL** 90° Angle w/black trim.

**49067-VUL** 90° Angle flow louvers.  
4.75" x 1.57" w/chrome trim

**49367-VUL** 90° Angle w/black trim.



**49050-VUL** Under dash louver For 2.5" hose.  
**49350-VUL** All black for 2.5" hose.  
**49250-VUL** Under dash louver For 3" hose.

**49059-VUL** Under dash louver For 2.5" hose.  
**49359-VUL** All black louver For 2.5" hose.



**63016-VUL** Double louver assembly 11.375" x 2.5". For 2.5" hose.  
**63316-VUL** (all black)

**63017-VUL** Double louver assembly 11.375" x 2.5". For 2" hose.  
**63317-VUL** (all black)

(Counts as 2 louvers on 4 louver packages)



# VINTAGE AIR



## LOUVERS - ProLine Upgrades

### Vintage Air Exclusive!

New!



**492056**  
55-57 Chevy ProLine chrome louver assembly (pair). Louvers included.  
**492055** - 55-57 Chevy ProLine brushed aluminum louver bezels (pair). Louvers not included. Fits standard round louvers and most ProLine round louvers.



**49215-VUQ**  
Slider Series all aluminum machined single louver. 2.75" outer diameter.



**49216-VUQ**  
Slider Series double louver. 4.31" wide x 2.31" tall.



**49054-VUQ**  
ProLine Streamline louver. Polished aluminum bezel with black injection molded ball. 2.875" outer diameter.

New Design!



**492161**  
Tri Bar Slider Series all aluminum machined single louver. 2.75" outer diameter.



**492162**  
Tri Bar Slider Series double louver. 4.31" wide x 2.31" tall.



**490541**  
ProLine Streamline louver. Anodized aluminum bezel with black injection molded ball. 2.875" outer diameter.



**49053-VUQ**  
Round louver brushed finish bezel with black injection molded black ball. 2.75" outer diameter.



**49210-VUQ**  
All aluminum Swivel Ball louver brushed finish. 2.625" outer diameter.  
**49210-VBQ**  
Black anodized.



**49212-VUQ**  
Venturi all aluminum machined louver. 2.875" outer diameter.



**499119**  
Proline Rotary Vane louver brushed finish. 2.62" outer diameter.  
**499112**  
Black anodized louver.

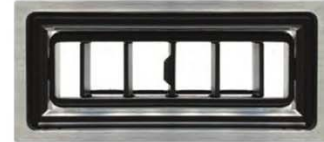

**49058-VUQ** Rectangle louver Billet trim. Face size 4.25" x 2"



**49062-VUQ** Streamline louver. Smooth polished aluminum trim. Face size 4" x 1.75"  
**490621** Black anodized trim with black vanes (shown)



**49063-VUQ** Streamline louver. Smooth polished aluminum trim. (shown) Face size 4.875" x 1.75"

New Design!



**491902**  
Oval louver with great flow! Chrome plated die cast housing with directional injection molded vanes. Face size 4.00" x 1.60"



**49202-VUQ** Brushed aluminum rectangle louver. 6" x 1.25" Face size



**49203 -VUQ** Brushed aluminum rectangle louver. 4" x 1.25" Face size

# VINTAGE AIR

## HEATING SYSTEMS

### NEW! Gen II HEATER 506101 Heater with defrost and servo door control

New design provides superior performance from servo motor controlled air door, improved case design and our exclusive electronic servo actuated heater control valve. New three knob control operates temp, fan speed and heat/defrost balance mode. Includes universal defrost ducts. Also may be used with optional dash louvers. (see below)

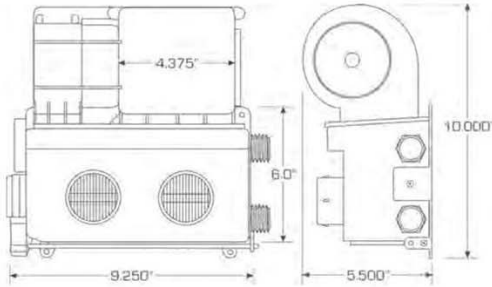

Included With Kit

Includes three knob control panel (knobs can be mounted directly into dash)

Includes Our Electronic Gen II Servo Controlled Heater Water Valve for positive temp adjustments

Redesigned For Improved Performance



### BI-LEVEL HEATER 50616-VUZ Heater with defrost

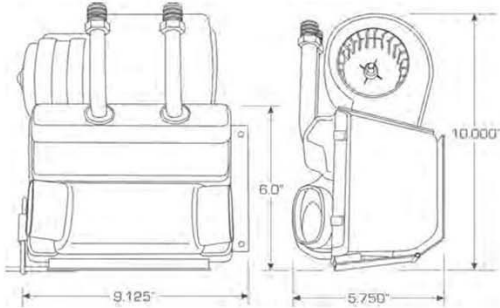

Great performance from Cuprobrazed® coil technology and improved case design. Single cable/switch control operates both air door actuation and fan speed. Cable operated door allows blending of heat between floor and ducts which can be used for defrost or with optional underdash vents in roadsters.



Cable Control

### COMPAC HEATER SERIES 50515-VUH Compact heater

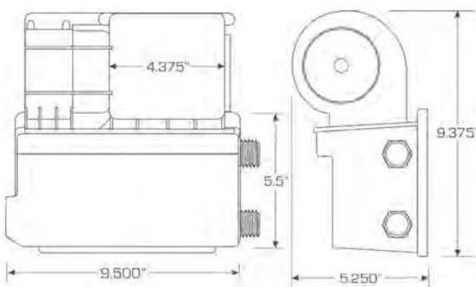

Included With Kit

Add electronic servo heater valve to any system See page 74



Optional Component

**49344-VUL** Optional underdash ball louvers - pair (all black)

**49044-VUL** Optional underdash ball louvers - pair (black with chrome ball)

Optional Component



These louvers will work with The Bi-Level Heater and our Gen II Heater at top of page.





# VINTAGE AIR



VA-49044-VUL	UNDER DASH BALL 2" HA	\$12.00
VA-49049-VUL	3" ROUND IN DASH LOUVER W/3"HA	\$14.00
VA-49050-VUL	UNDER DASH CENTER LOUVER	\$12.00
VA-49051-VUL	LEFT KICK PANEL LOUVER	\$12.00
VA-49052-VUL	LOUVER DASH 4 3/4 X 2 1/2 IN	\$12.00
VA-490535	CHROME DOUBLE VANE LOUVER	\$13.00
VA-49053-VUL	2.875 X 2.5 CHR IN DASH LOUVR	\$11.00
VA-49053-VUQ	OUTLET PROLINE ROUND BILET	\$37.00
VA-49054-VUL	LOUVER UNDER DASH BALL	\$12.00
VA-49054-VUQ	OUTLET PROLINE ROUND DECO	\$62.00
VA-49055-VUL	LOUVER DASH 3.75" X 1.50"	\$12.00
VA-49056-VUL	3 1/2 X 1 1/2 IN DASH LOUVER	\$12.00
VA-49057-VUL	LOUVER DASH 4 3/4 X 1 1/2 IN	\$12.00
VA-49058-VUQ	OUTLET PROLINE RECTANGLE	\$33.00
VA-49059-VUL	UNDERDASH RECTANGLE LOUVER	\$14.00
VA-49062-VUQ	STREAMLINE LOUVER 3 15/16	\$56.00
VA-49063-VUQ	LOUVER STREAMLINE 4 3/4	\$56.00
VA-49066-VUL	LOUVER W/90 ADAPT 3 7/8 X 4 9/16	\$15.00
VA-49067-VUL	LOUVER W/90 ADAPT 4 3/4 X 9/16	\$15.00
VA-49151-VUL	RIGHT KICK PANEL LOUVER	\$12.00
VA-49153-VUL	CHROME BALL LOUVER	\$11.00
VA-49154-VUL	STANDARD LOUVER CHROME	\$17.00
VA-49193-VUL	DOUBLE VANE LOUVER BLACK	\$11.00
VA-49202-VUQ	LOUVER ALUM SLIMLINE 6" X 1.25	\$136.00
VA-49203-VUQ	LOUVER ALUM SLIMLINE 4" X 1.25	\$136.00
VA-49210-VBQ	LOUVER ANODIZED PROLINE BLK	\$112.00
VA-49210-VUQ	LOUVER ALUM PROLINE RD	\$97.00
VA-49212-VUQ	LOUVER VENTURI 2.5	\$93.00
VA-49215-VUQ	SGNL SLYDER LVR ASSY - ALUM	\$145.00
VA-49216-VUQ	DBLE SYLDER LVR ASSY - ALUM	\$295.00
VA-49250-VUL	UNDERDASH LOUVER W/3" H.A.	\$15.00
VA-49251-VUL	LEFT KICK PANEL LOUVER W/3" H.A.	\$15.00
VA-49252-VUL	RIGHT KICK PANEL LOUVER W/3" H.A.	\$15.00
VA-49256-VUL	LOUVER DASH 3 1/2 X 1 1/2 IN	\$12.00
VA-49325-VUL	LOUVER 4.75" X 1.50" BLACK	\$12.00
VA-49326-VUL	LOUVER 3.50" X 1.50" BLACK	\$12.00
VA-49327-VUL	LOUVER 3 7/8 X 2 ALL BLACK	\$12.00
VA-49344-VUL	UNDER DASH BALL 2" HA BLK	\$20.00
VA-49350-VUL	UNDER DASH CENTER LOU BLACK	\$12.00
VA-49351-VUL	RIGHT KICK PANEL LOU BLACK	\$12.00
VA-49352-VUL	LOUVER DASH 4 3/4 X 2 1/2" BLK	\$12.00
VA-49353-VUL	LOUVER 2 7/8 X 2 1/2 ALL BLACK	\$11.00
VA-49354-VUL	LOUVER UNDER DASH BALL BLK	\$12.00
VA-49355-VUL	LOUVER DASH 3 3/4 1 1/2 BLK	\$12.00
VA-49356-VUL	LOUVER W/2 1/2 HA 3-7/BX 1-9/16	\$12.00
VA-49361-VUL	LEFT KICK PANEL LOU BLK	\$12.00
VA-49366-VUL	LOUVER W/90 ADAP 3-78 X 1-9/16	\$15.00

# VINTAGE AIR



VA-49367-VUL	LOU W/90 ADAP 4-3/4 X 1-9/16 BLK	\$15.00
VA-49393-VUL	DOUBLE VANE UNDER DASH LOUVER	\$12.00
VA-490621	STREAMLINE LOUVER RECTANGLE	\$83.00
VA-490622	STREAMLINE LOUVER RECTANGLE	\$83.00
VA-491210-RUA	STRM LINE 3 KNOB PANEL	\$245.00
VA-491214-RVA	STRM LINE 3 KNOB VERT PANEL	\$245.00
VA-491223-RUA	STRM LINE 3 KNOB PLN KIT HOR BLK ANODZ	\$262.00
VA-491226-RVA	STRM LINE 3 KNOB PLN KIT VERT BLK ANODZ	\$262.00
VA-491902	PROLINE OVAL LOUVER	\$124.00
VA-492056	55-57 CHEVY CHROME LOUVER BEZEL ASM (PAIR)	\$214.00
VA-492162	PROLINE DOUBLE LOUVER	\$344.00
VA-499112	PROLINE ROTARY VANE ASM BLK ANODIZE	\$157.00
VA-499119	PROLINE ROTARY VANE ASM CLEAR ANODIZE	\$140.00
VA-50515-VUH	COMPAC HEATER KIT	\$214.00
VA-50616-VUZ	BI-LEVEL HEATER W/DEF	\$305.00
VA-56155-PCZ	55-56 CHEVY EVAPORATOR KIT	\$955.00
VA-56156-PCZ	55-56 CHEVY VENT EVAPORATOR KIT	\$955.00
VA-506101	GEN II HEATER W/ DEFROST	\$377.00
VA-551170	1969-70 MUSTANG w/o FACTORY A/C EVAP KIT	\$955.00
VA-554164	1964-66 MUSTANG GEN IV EVAP KIT	\$955.00
VA-561057	57 CHEVY EVAPORATOR KIT	\$955.00
VA-561058	57 CHEVY 4-VENT EVAPORATOR KIT	\$955.00
VA-561059	58-60 CORVETTE GEN IV EVAPORATOR KIT	\$955.00
VA-561060	61-62 CORVETTE GEN IV EVAPORATOR KIT	\$955.00
VA-561062	61-62 IMPALA w/o AC GEN IV EVAP KIT	\$955.00
VA-561063	1963 IMPALA w/o AC GEN IV EVAP KIT	\$955.00
VA-561064	1964 IMPALA w/o AC GEN IV EVAP KIT	\$955.00
VA-561065	64-65 CHEVELLE w/o A/C EVAP KIT	\$955.00
VA-561066	1966-67 CHEVELLE w/o AC GEN IV EVAP KIT	\$955.00
VA-561067	64-67 GTO W/O AC GEN IV EVAP KIT	\$955.00
VA-561068	1968-69 CHEVELLE w/o AC GEN IV EVAP KIT	\$955.00
VA-561069	68 NOVA W/O AC GEN IV EVAPKIT	\$955.00
VA-561071	1970-72 CHEVELLE w/o AC GEN IV EVAP KIT	\$955.00
VA-561072	69-72 NOVA W/ AC GEN IV EVAPKIT	\$955.00
VA-561164	1962-65 NOVA AC GEN IV EVAP KIT	\$955.00
VA-561166	1966-67 NOVA AC GEN IV EVAP KIT	\$955.00
VA-561167	67-68 CAMARO w/o AC GEN IV EVAP KIT	\$955.00
VA-561169	1969 CAMARO w/o AC GEN IV EVAP KIT	\$955.00
VA-561170	70-78 CAMARO w/o AC GEN IV EVAP KIT	\$955.00
VA-561174-PCZ	68-76 CORVETTE w/o AC EVAP KIT	\$955.00
VA-564062	61-62 IMPALA w/ AC GEN IV EVAP KIT	\$955.00
VA-564063	1963 IMPALA w/ AC GEN IV EVAP KIT	\$955.00
VA-564064	1964 IMPALA w/ AC GEN IV EVAP KIT	\$955.00
VA-564167	67-68 CAMARO w/ A/C GEN IV EVAP KIT	\$955.00
VA-564169	69 CAMARO w/ A/C GEN IV EVAP KIT	\$955.00
VA-564173-PCZ	68-76 VETTE W/AC EVAP KIT	\$955.00
VA-564464	64-65 CHEVELLE w/ A/C EVAP KIT	\$955.00

# VINTAGE AIR



VA-564466	66-67 CHEVELLE w/ AC GEN IV EVAP KIT	\$955.00
VA-564467	64-67 GTO W/ AC GEN IV EVAP KIT	\$955.00
VA-564471	68-69 CHEVELLE w/ AC GEN IV EVAP KIT	\$955.00
VA-565069	68 NOVA W/ AC GEN IV EVAPKIT	\$955.00
VA-565071	70-72 CHEVELLE w/ AC GEN IV EVAP KIT	\$955.00
VA-565072	69-72 NOVA W/ AC GEN IV EVAPKIT	\$955.00
VA-571074-EDZ	70-74 CHALNGR/CUDA W/O AC EVAP KIT	\$955.00
VA-574073-EDZ	70-74 CHALNGR/CUDA W/AC W/RD EVAP KIT	\$955.00
VA-574074-EDZ	70-74 CHALNGER/CUDA W/AC EVAP KIT	\$955.00
VA-63016-VUL	11 3/8 X 2 1/2 LOUVER W/2 1/2 HA	\$26.00
VA-63017-VUL	DOUBLE LOUVER 2"	\$42.00
VA-63316-VUL	DOUBLE LOUVER BLACK 2.5"	\$37.00
VA-63317-VUL	DOUBLE LOUVER BLACK 2"	\$42.00
VA-671400-VUZ	GEN IV MAGNUM EVAP KIT	\$864.00
VA-671450	GEN IV MAGNUM MOCK-UP UNIT	\$83.00
VA-751170	67-72 CHEVY P/U W/O AC GEN IV EVAPORATOR KIT	\$955.00
VA-751171	67-72 CHEVY P/U W/O AC FOR FAC. AC CNTRLS GEN IV	\$955.00
VA-754170	67-72 CHEVY P/U W/AC GEN IV EVAPORATOR KIT	\$955.00

# COMPRESSOR REFERENCE

MANUF. NUMBER	SUBSTITUTE NUMBER	DESCRIPTION	RANSHU NUMBER	VISTEON NUMBER	OMEGA NUMBER
4508		5 H 14 PVID V O-RING EAR	14-SD4508NC	010263	20-10185
4526		SD 508 10 GRV H-1x14 EAR	14-SD4526NC		
5017	5070	SD 505 5.25" 4 GROOVE POLY V PAD	14-SD5017NC		20-10129
5072	5012	SD H09 4 GRV V-OR	14-SD5072NC		20-10062
5104		SD 507 2 AGR V O-RING EAR	14-SD5104NC		20-10123
7246		SD 708 4.75" 8 GROOVE POLY V PAD	14-SD7246NC		20-10098
7320		SD 708 4.75" 8 GROOVE POLY V O-RING S	14-SD7320NC		20-10190
7321		SD 708 5.00" 2 GROOVE O-RING S	14-SD7321NC		
7712		SD 709 PV6 H 1x14 DIRECT	14-SD7712NC	010221	
7730		SD 709 PV8 H-ORING DIRECT	14-SD7730NC	010222	20-10027
8390	25022	SD 508 5.25" 2A GROOVE FLARE	14-SD8390NC	010226	20-10102
9056	5012 (W/ADAP)	SD 505 4.75" 2A GROOVE FLARE	14-SD9056NC	010228	20-10100
9175		SD 507 PV 10 V-FLARE	14-SD9175NC	010238	
9537	25051	SD 508 4.75" 7 GROOVE POLY V O-RING	14-SD9537NC	010246	20-10107
23025	9283	SD 508 7 GRV V-FLARE	14-DK23025NC	010239	20-10103
25021	9285	TM-15 5.25" 2A GROOVE O-RING	14-DK25021NC	010172	20-10202
25051	9537	TM-15 4.75" 7 GROOVE POLY V O-RING	14-DK42038NC	010175	
42038	52038	TM-08 4.75" 6 GROOVE POLY V O-RING	14-DK42038NC	010267	
52080		TM-08 4.75" 4 GROOVE POLY V O-RING S	14-DK52080NC	010255	20-52080
52110	42120	TM-13A 5.20" 2A GROOVE O-RING E	14-DK52110NC	010285	20-42110
52114	44121	TM-13 5.25" 6 GROOVE POLY V O-RING E	14-DK52114NC	010283	20-10245
52118		TM-13A SINGLE OVERHANG O-RING	14-DK52118NC		
52120	7312	TM-13A 5.25" 2A GROOVE S	14-DK52120NC		20-52120
52310	7312	TM 13A 5.20" 2A GROOVE S	14-DK52310NC		
53009		TM-15 4.75" 6 POLY V S	14-DK53009NC		
54038		TM-15 PV8 MANIFORLD V O-RING	14-DK54038NC		
54120	4514	TM-15 8 GROOVE POLY V E	14-DK54120NC		20-44120
54334	45234	TM-15 8 GRV POLY REAR PRT NO MANIFOLD S	14-DK54334NC		
55011		TM-15 HD 2 GRV V O-RING	14-DK55011NC	010176	
55021	45321	TM-15 5.25" 2A GROOVE O-RING E	14-DK55021NC		20-55021
55030		TM-15 5.25" 2A GROOVE O-RING E	14-DK55030NC	010177	20-10236
55033	45063	TM-15 4.50" 1 GROOVE OVERHANG S	14-DK55033NC	010251	20-10295
55051	35-0039	TM-15 4.75" 7 GROOVE POLY V O-RING S	14-DK55051NC		
55052	45122	TM-15 4.75" 7 GROOVE POLY V O-RING	14-DK55052NC		
55086	4628	TM-15 4.75" 6 GROOVE POLY O-RING S	14-DK55086NC		
55088	4628	TM-15 4.75" 6 GRV DIRECT V-OR E	14-DK55088NC		20-45088
55120	45141	TM-15 HD 8 GRV PLY V V-OR S	14-DK55120NC		
55121	45141	TM-15 PV8 V-ORING EAR	14-DK55121NC		20-55121
55122	46052	TM-15 4.75" 8 GROOVE BHOR E	14-DK55122NC		20-55122
55141	4514	TM 16 4.75" 8 GROOVE S	14-DK55141NC		
55234	44334	TM-15 4.75" 8 GROOVE POLY V E	14-DK55234NC		
55321	4509	TM-15 4.75" 2 GROOVE S	14-DK55321NC		
56121	4514	TM-15 4.75" 8 GROOVE CVOR	14-DK56121NC		
56234		TM16HD 8 EAR HORIZONTAL PAD 125MM	14-DK56234NC	010275	

## CLUTCH AIR GAPS

UNIT MODEL	REMARKS	CLEARANCE
<b>GM COMPRESSORS</b>		
A6	PRESS FIT	.022" - .057"
R4	PRESS FIT	.020" - .040"
DA, HR6, HR6E, V5	PRESS FIT	.015" - .025"
<b>NIPPONDENSO COMPRESSORS</b>		
CHRYSLER C171, A590	SHIM ADJUSTABLE	.020" - .035"
10PA17C-LASER, TALON	SHIM ADJUSTABLE	.014" - .0265"
6C17, 10PA17-ALL OTHERS	SHIM ADJUSTABLE	.020" - .035"
FORD FS6, 6P148, 10PA17C	SHIM ADJUSTABLE	.020" - .035"
FORD 10P13, 10P15C, 10P15F	SHIM ADJUSTABLE	.020" - .035"

UNIT MODEL	REMARKS	CLEARANCE
10P15A	SHIM ADJUSTABLE	.016" - .028"
FX15	SHIM ADJUSTABLE	.013" - .033"
GM10PA20, 10P15	SHIM ADJUSTABLE	.014" - .026"
ALL OTHERS	SHIM ADJUSTABLE	.020" - .035"
<b>SANDEN/SANKYO COMPRESSORS</b>		
SD 508, 510, 709	SHIM ADJUSTABLE	.016" - .031"
TR015	SHIM ADJUSTABLE	.013" - .025"
<b>TECUMSEH COMPRESSORS</b>		
HR980	SHIM ADJUSTABLE	.020" - .040"

## COMPONENT REPLACEMENT OIL CAPACITY

COMPONENT	TYPE	CAPACITY
ACCUMULATORS / RECEIVER DRIERS	ALL TYPES	1 oz.
CONDENSERS	ALL TYPES	1 oz.
EVAPORATOR CORES		
	AMC	1 oz.

COMPONENT	TYPE	CAPACITY
	CHRYSLER	2 oz.
	FORD - GM	3 oz.
	IMPORTS	1 oz.

## COMPRESSOR REPLACEMENT PROCEDURE

- 1) FLUSH THE SYSTEM USING O.E.M. APPROVED EQUIPMENT. SOME HOSES AND CONDENSERS WILL NOT FLUSH (REPLACE)
- 2) CHANGE THE FILTER DRIER OR ACCUULATOR
- 3) THE ORFICE TUBE OR LIQUID LINE CONTAINING THE ORFICE TUBE MUST BE REPLACED IF THE SYSTEM CONTAINS ONE
- 4) THE EXPANSION DEVICE MUST BE CLEANED AND INSPECTED OR REPLACED
- 5) FILL THE SYSTEM WITH R12 OR R134 AS NO OTHER REFRIGERANT IS APPROVED BY THE O.E.M. MANUFACTURERS
- 6) THE RADIATOR AND CONDENSER MUST BE CHECKED FOR PROPER AIR FLOW
- 7) THE FAN CLUTCH OR ELECTRIC FAN MUST BE IN WORKING CONDITON
- 8) THE COMPRESSOR CLUTCH AIR GAP MUST BE CHECKED AND ADJUSTED TO O.E.M. SPECIFICATIONS PRIOR TO INSTALL
- 9) THE CORRECT AMOUNT OF THE CORRECT OIL MUST BE ADDED TO THE A/C SYSTEM
- 10) THE COMPRESSOR SHAFT MUST BE ROTATED USING THE PROPER TOOL BEFORE STARTING THE ENGINE
- 11) THE A/C CLUTCH CIRCUIT MUST BE CHECKED FOR PROPER VOLTAGE DURING COMPRESSOR OPERATION
- 12) THE A/C SYSTEM MUST BE PROPERLY EVACUATED

# COMPRESSOR OIL CAPACITIES

**THIS CHART IS FOR REFERENCE ONLY, PLEASE SEE OWNER'S MANUAL FOR SPECIFIC APPLICATIONS**

MFG	MODEL	SYS OZ'S	MFG	MODEL	SYS OZ'S
BEHR	WING CELL	10.0	MATSUSHITA	ALL	4.5
	AXIAL	11.5	MITSUBISHI	FX-80	7.9-9.1
CALSONIC	SEE NIHON			AX-105VSR	5.1-5.7
CHRYSLER	A590	7.3		MSC	5.0-7.4
	C171	7.3	NIHON	CR-14	4.2-5.9
	RV2	11.0		DKV	5.0
DENSO	6C-17	8.7		NVR	6.8
	6CA	5.2		DCV	5.0-6.6
	6E	8.0-10.0		CWV	6.8
	6P	8.0-10.0		V-5	3.2
	6SEU	5.4-6.8		V6-18A	6.8
	7SB	5.4-6.8	SANDEN	SD5	4.6-5.9
	10P'S	8.0-10.0		708	8.5
	10PA15	4.1		709	8.5
	10PA17	10.0		TR70	4.0-5.0
	10PA20	5.4-8.0		TR90	4.0-5.0
	10S11	3.5-7.0		TRF090	4.0-5.0
	10S13	3.5-8.7		TRS090	4.0-5.0
	10S15	6.0-8.0		7H15	8.5
	10S17	4.7-8.2		SD6V12	4.5
	10S20	8.0-11.0		SD7V16	4.5
	SC06	7.0		PXV16	4.0
	SC08	7.0	SEIKO-SEIKI	ALL	6.8-7.8
	TV	7.7	TECUMSEH/ YORK	ALL	11.0
DELPHI/GM	A6	10.0			
	DA6/HR6/V5	8.0-9.0			
	CVC	5.0			
	R4	8.0-11.0			
	SP15	5.6-7.2			
DIESEL KIKI/ SELTEC/ZEXEL	TM TYPE	6.0-7.0			
	DCW	8.5			
	DKS17D	6.0			
	DKS 26	VARIOUS			
FORD	FS6	7.0			
	FS10/FX15	7.0			
	SCROLL	9.0-13.0			
HADSYS	RC-17D	4.3			
	RC-17S	4.3			
HALLA	HS15	7.75			
	HS17	5.5			
	HS18	6.0			
HITACHI	ALL	5.1-9.1			
KEIHIN	RADIAL	6.9			
	HS090R	4.5			
	HS110R	5.0			
MATSUSHITA/ PANASONIC	ALL	4.5			



# COMPRESSOR PRESSURE GUIDE

HUMIDITY/TEMPERATURE/PRESSURE RELATIONSHIPS





ENGINE SPEED = 2000 R.P.M.

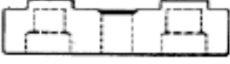
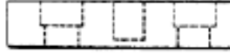

RELATIVE HUMIDITY %	AMBIENT AIR TEMP DEGREE F°	R12			R134a		
		MAXIMUM LOW SIDE PSIG	MAXIMUM HIGH SIDE PSIG	CENTER DUCT AIR TEMP (F°)	MAXIMUM LOW SIDE PSIG	MAXIMUM HIGH SIDE PSIG	CENTER DUCT AIR TEMP (F°)
20%	70°	29	150	40°	37	225	46°
	80°	29	190	44°	37	275	47°
	90°	30	245	48°	37	325	53°
	100°	31	305	57°	38	325	54°
30%	70°	29	150	42°	37	240	48°
	80°	30	205	47°	37	285	50°
	90°	31	265	51°	39	340	57°
	100°	32	325	61°	43	360	60°
40%	70°	29	165	45°	37	260	49°
	80°	30	215	49°	37	305	53°
	90°	32	280	55°	42	455	60°
	100°	39	345	65°	49	395	66°
50%	70°	30	180	47°	37	275	51°
	80°	32	235	53°	39	320	56°
	90°	34	295	59°	46	375	63°
	100°	40	350	69°	55	430	72°
60%	70°	30	180	49°	37	290	53°
	80°	33	240	56°	42	340	59°
	90°	36	300	63°	49	390	66°
	100°	43	360	73°	60	445	78°
70%	70°	30	180	50°	37	305	55°
	80°	34	245	58°	45	355	62°
	90°	38	305	65°	53	405	70°
80%	70°	30	190	50°	41	320	56°
	80°	34	250	59°	48	370	65°
	90°	39	310	67°	57	420	73°

## METRIC TO STANDARD CONVERSION CHART

FRACTIONS	DECIMAL IN.	METRIC MM.	FRACTIONS	DECIMAL IN.	METRIC MM.	FRACTIONS	DECIMAL IN.	METRIC MM.
1/64	.015625	.39688	15/32	.46875	11.90623	59/64	.921875	23.41562
1/32	.03125	.79375	31/64	.484375	12.30312	15/16	.9375	23.81250
3/64	.046875	1.19062	1/2	.500	12.70000	61/64	.953125	24.20937
1/16	.0625	1.58750	33/64	.515625	13.09687	31/32	.96875	24.60625
5/64	.078125	1.98437	17/32	.53125	13.49375	63/64	.984375	25.00312
3/32	.09375	2.38125	35/64	.546875	13.89062	1	1.00	25.40000
7/64	.109375	2.77812	9/16	.5625	14.28750			
1/8	.125	3.1750	37/64	.578125	14.68437			
9/64	.140625	3.57187	19/32	.59375	15.08125			
5/32	.15625	3.96875	39/64	.609375	15.47812			
11/64	.171875	4.36562	5/8	.625	15.87500			
3/16	.1875	4.76250	41/64	.640625	16.27187			
13/64	.203125	5.15937	21/32	.65625	16.66875			
7/32	.21875	5.55625	43/64	.671875	17.06562			
15/64	.234375	5.95312	11/16	.6875	17.46250			
1/4	.250	6.35000	45/64	.703125	17.85937			
17/64	.265625	6.74687	23/32	.71875	18.25625			
9/32	.28125	7.14375	47/64	.734375	18.65312			
19/64	.296875	7.54062	3/4	.750	19.05000			
5/16	.3125	7.93750	49/64	.765625	19.44687			
21/64	.328125	8.33437	25/32	.78125	19.84375			
11/32	.34375	8.73125	51/64	.796875	20.24062			
23/64	.359375	9.12812	13/16	.8125	20.63750			
3/8	.375	9.52500	53/64	.828125	21.03437			
25/64	.390625	9.92187	27/32	.84375	21.43125			
13/32	.40625	10.31875	55/64	.859375	21.82812			
27/64	.421875	10.71562	7/8	.875	22.22500			
7/16	.4375	11.11250	57/64	.890625	22.62187			
29/64	.453125	11.50937	29/32	.90625	23.01875			

# GM SEALING WASHER INSTRUCTIONS

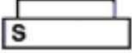
Section 1 - HOSE BLOCKS INSERTS				
Column A	Compressor Suction Port Size	Column B		Column C
Hose Block Side View		Suction Seal Washer 5/8" 3/4"		Discharge Seal Washer 5/8"
 <p>1. Flat Face Hose Block with 4mm Pilots</p>	5/8"	C	---	E/ S
	3/4"	B	---	E/ S
 <p>2. Flat Face Hose Block with No Pilots</p>	5/8"	C/S	---	E/ L
	3/4"	B/S	---	---
 <p>3. Raised Face Hose Block with 7mm Pilots</p>	5/8"	D	---	F
	3/4"	B	A	E/F
 <p>4. Step Hose Block with 7mm Pilots</p>	5/8"	D	---	D
	3/4"	---	A	D
 <p>5. Step Hose Block with Tube Pilot</p>	5/8"	G	---	G
	3/4"	---	---	---

Section 2 - PILOT INSERTS	
 <p><b>S</b> Small</p>	<p>Carquest Kit Part No.: 207274 &amp; 207279</p> <p>Large Diameter: 16.0 mm (.63 in) Overall Length: 7.1 mm (.28 in) Small Diameter: 12.9 mm (.51 in)</p>
 <p><b>L</b> Large</p>	<p>Carquest Kit Part No.: 207274</p> <p>Large Diameter: 16.0 mm (.63 in) Overall Length: 11.4mm (.45 in) Small Diameter: 12.9 mm (.51 in)</p>



## NOTE:













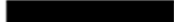

- 1) Compare the side view of the hose manifold to the diagrams in Section 1 Column A.
- 2) Select the diagram that matches the hose manifold.
- 3) Determine the size of the pilot holes (SUCTION and DISCHARGE) on the manifold hose assembly. The Size of the pilot holes will be either 5/8" or 3/4".
- 4) The letter indicating the correct sealing washer is listed with the correct pilot insert letter size.
- 5) The sealing washer diagram is Section 3.
- 6) Using the diameter of the pilot, determine the correct SUCTION sealing washer and pilot insert (Column B).
- 7) Using the diameter of the pilot holes, determine the correct DISCHARGE sealing washer and pilot insert (Column C).
- 8) Remove the proper insert and washer from the kit.
- 9) Lubricate washer with R12 lubrication mineral oil.
- 10) Install the sealing washer and pilot insert (if needed) onto the manifold block fitting.
- 11) Inserts must be fully seated, and sealing washers must be bottomed out against the block surface.
- 12) Install manifold block to compressor. A small space between manifold and compressor is normal. Torque Bolt to 25 ft/lbs.

## IMPORTANT:

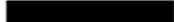
**All sealing surfaces must be lint and dirt free.**



# GM SEALING WASHER INSTRUCTIONS

Section 3 - Sealing Washers		
		<b>Edge Color:</b> Metal <b>Thickness:</b> 1.3mm (.05 in) <b>Outside Diameter:</b> 31.5mm (1.24 in) <b>Inside Diameter:</b> 17.5mm (.69 in)
		<b>Edge Color:</b> Yellow <b>Thickness:</b> 3.0mm (.12 in) <b>Outside Diameter:</b> 33.2mm (1.31 in) <b>Inside Diameter:</b> 15.5mm (.61 in)
		<b>Edge Color:</b> Black <b>Thickness:</b> 3.0mm (.12 in) <b>Outside Diameter:</b> 27.9mm (1.10 in) <b>Inside Diameter:</b> 15.5mm (.61 in)
		<b>Edge Color:</b> Metal <b>Thickness:</b> 1.2mm (.05 in) <b>Outside Diameter:</b> 27.9mm (1.10 in) <b>Inside Diameter:</b> 15.5mm (.61 in)
		<b>Edge Color:</b> Green <b>Thickness:</b> 5.5mm (.22 in) <b>Outside Diameter:</b> 29.9mm (1.18 in) <b>Inside Diameter:</b> 15.5mm (.61 in)
		<b>Edge Color:</b> Red <b>Thickness:</b> 3.8mm (.15 in) <b>Outside Diameter:</b> 29.9mm (1.18 in) <b>Inside Diameter:</b> 15.5mm (.61 in)
		<b>Edge Color:</b> Metal <b>Thickness:</b> 1.2mm (.05 in) <b>Outside Diameter:</b> 23.6mm (.93 in) <b>Inside Diameter:</b> 15.5mm (.61 in)

# GM SEALING WASHER INSTRUCTIONS

## GM SEALING WASHER RETROFIT ASSEMBLY INSTRUCTIONS

### Sealing Washer Installation

When installing sealing washers, keep dirt or foreign material from getting on the sealing surfaces of the washers, hose block or compressor ports. Clean all sealing surfaces with a lint-free rag.

- \* Do not reuse sealing washers.
  - \* Sealing washers do not have to be oiled prior to assembly.
1. Install sealing washers onto pilots of suction/discharge block fitting. Washers must bottom against surface of block fitting.
  2. Install hose block to the compressor making sure the sealing washers are seated within the compressor machined surfaces.
  3. Hold block in place, hand tighten attachment bolt or nut.
  4. Torque attachment bolt to 34 N-m. If correct washer kit was used there should be a 1.2 mm space between the suction/discharge hose block and the compressor rear head.

### Inserts

1. Rigidly support suction/discharge hose block and tap aluminum inserts into block until seated.
2. Install sealing washers per above instructions.

**Caution:** Exposed edges of inserts nicked or burred during insert assembly may result in damage to sealing washer when it is assembled onto the inserts.

## SEALING WASHER RETROFIT APPLICATIONS FOR HARRISON COMPRESSORS

(USE ONLY WITH NON-STEP HOSE BLOCKS)

SUCTION/DISCHARGE HOSE BLOCK CONFIGURATIONS				
KEY				
	FLAT FACE HOSE BLOCK WITH SHORT PILOTS	FLAT FACE HOSE BLOCK WITH NO PILOTS	RAISED FACE HOSE BLOCK WITH TWO 5/8" LONG PILOTS	RAISED FACE HOSE BLOCK WITH 5/8" AND 3/4" LONG PILOTS
COMPRESSOR CONFIGURATIONS	2724887 or 52380416, 2724575 or 52380414	2724887 or 52380416, 2724575 or 52380414	2724887 or 52380416, 2724575 or 52380414	
COMPRESSORS WITH 5/8" SUCTION AND 5/8" DISCHARGE PORTS	SUCTION (BLACK) 52457910 DISCHARGE (GREEN) 2724890 SHORT INSERT (DISCH.) 6559423	SUCTION (BLACK) 52457910 DISCHARGE (GREEN) 2724890 SHORT INSERT (SUCT.) 6559423 LONG INSERT (DISCH.) 2724891	SUCTION (THIN 5/8") 52455752 DISCHARGE (RED) 2724889	
	2724887 or 52380416		2724887 or 52380416	2724887 or 52380416, 2724578 or 52380419
COMPRESSORS WITH 3/4" SUCTION AND 5/8" DISCHARGE PORTS	SUCTION (YELLOW) 2724888 DISCHARGE (GREEN) 2724890 SHORT INSERT (DISCH.) 6559423		SUCTION (YELLOW) 2724888 DISCHARGE (GREEN) 2724890	SUCTION (THIN 3/4") 52455756 DISCHARGE (RED) 2724889